



OWNERS AND SERVICE MANUAL

INNOVATIVE CONCEPTS IN ENTERTAINMENT INC.

10123 MAIN STREET, CLARENCE, NY 14031

SERVICE: 1-716-759-0360

FAX: 1-716-759-0884

E-MAIL: service@icegame.com

WEBSITE: www.icegame.com

INTRODUCTION

GAME FEATURES

The new MINI CRANE by I.C.E. was designed with the operator in mind. Reliability, low maintenance, available custom cabinetry, and all metal exterior construction are some of the most important design features to be added to the newest member of our crane family.

To keep things easy for the operator, all of our best features have been carried over from our other designs. Things such as an all-metal exterior, powdered epoxy paint, tempered glass windows, and full-featured programming are standards you've come to expect from I.C.E. products.

The MINI CRANE uses state of the art electronics with a new drive circuit for all motors. In our new design, even direct short circuits can't damage the motor or coil drivers. The protection is built into the drivers themselves! Another advantage is that the new board incorporates modular driver circuits so the same main board can be used on multiple products.

This crane has been made to give you a crane that is competitive with other smaller cranes of its size, but it has been engineered to leave the competition behind. Every aspect of small crane design has been scrutinized and improved to bring it up to the standards necessary to compete in today's market.

We hope you thoroughly enjoy your ownership experience with your new MINI CRANE. If you have any questions or comments, please contact our service department at: (716) 759-0360.

GAME PLAY

As coins are inserted into the MINI CRANE a coin in sound will be heard. When sufficient coins have been inserted, the game sound starts, the claw clicks closed and re-opens, which signals the start of the game. The crane will position its self in the middle of the "play field" and remain there, with the cranes sound theme playing until the player is ready.

When the player has moved the joystick or pressed the buttons, to move the crane, the timer on the right display will begin to count down. The player will position the crane above the prize and they are attempting to win and press the drop button to lower the claw.

If the nudging option is on, then the player will have the ability to keep "nudging" the claw down each time the button is pressed to hone in on the chosen prize. If the nudging option is off, then the player will have only one chance to drop the claw.

When the claw is fully dropped it will close and retract to its upper most position. The crane will then automatically position its self over the prize chute at the rear of the cabinet. The claw will open, releasing the prize (if grabbed) into the prize chamber. The player can now remove the prize from the chamber through the prize door located in the front, lower left corner of the game. The game is now in its home position and is ready for the next player in line.

SET-UP / TESTING / MAINTENANCE

SAFETY PRECAUTIONS

IMPORTANT: FAILURE TO FOLLOW THESE DIRECTIONS CLOSELY COULD CAUSE SERIOUS DAMAGE TO YOUR GAME.

WARNING: WHEN INSTALLING THIS GAME, A 3 PRONG GROUNDED RECEPTACLE MUST BE USED. FAILURE TO DO SO COULD RESULT IN SERIOUS INJURY

TO YOURSELF OR OTHERS. FAILURE TO USE A GROUNDED RECEPTACLE COULD ALSO CAUSE IMPROPER GAME OPERATION, OR DAMAGE TO THE ELECTRONICS.

DO NOT DEFEAT OR REMOVE THE GROUNDING PRONG ON THE POWER CORD FOR THE SAME REASONS

AS GIVEN ABOVE. USING AN IMPROPERLY GROUNDED GAME COULD VOID YOUR WARRANTY.

GAME SET-UP

BEFORE PLUGGING THE GAME IN, OR TURNING IT ON, BE SURE THE GAME HAS BEEN SET TO THE PROPER VOLTAGE. YOUR GAME SHOULD COME PRE-SET FROM THE FACTORY CORRECT VOLTAGE, HOWEVER IT IS A GOOD IDEA TO CHECK THE A.C. WALL RECEPTACLE VOLTAGE BEFORE PLUGGING THE GAME IN.

ASSEMBLY INSTRUCTIONS

1. Carefully un-box the game from its packaging.
2. Using the supplied keys, unlock the front door of the cabinet.
3. Cut all tie wraps holding the wagon assembly and crane in place.
4. Plug the game into a three prong grounded receptacle. NOTE: The appliance must be positioned such that the plug is accessible during use.
5. The game is now ready for start up.

TESTING

After the initial setup, it is time to test your game for proper operation.

1. Locate the game in its permanent location.
2. Be sure the game has been properly plugged into a 3 prong grounded outlet, and that the receptacle is in good working order.
3. If using an extension cord, be sure it is a 3 prong grounded type of at least 16Ga.
4. Verify that the game is set up for the proper voltage, and turn the power to the game on.
5. The game will run through a test mode at every startup. See test mode explanation in the programming section for details.
6. Insert coins/bills into the machine at least ten times into the coin mech/bill acceptor to assure proper operation
7. Check the credit and prize counters for proper
8. operation.
9. Check game volume during busy time at location to set it at the proper level.

CLEANING

Regular cleaning of this game will keep it looking new, and greatly enhance its appeal.

Clean the windows of your MINI CRANE with a standard window cleaner such as Windex®

Clean the cabinet sides with a good cleaner such as "Fantastic" or "409" and a soft rag. A mild soapy solution can be used. You may use a furniture polish when finished to protect the game and make it look more attractive,

NOTE: DO NOT USE ALCOHOL, THINNERS OF ANY KIND, OR PINBALL PLAY FIELD CLEANERS ON ANY OF THE CABINET SURFACES ESPECIALLY THE DECALS.

IF YOU HAVE ANY QUESTIONS OR COMMENTS REGARDING INSTALLATION OR PROPER FUNCTION OF YOUR GAME, PLEASE CALL OUR SERVICE DEPARTMENT AT 1-716-759-0360.

PROGRAMMING

ENTERING THE PROGRAMMING MODE

To enter the programming mode, open the front door and press the button marked PROG. Located on the main board housing inside the front door and the crane will move to the front center of the game.

Once you are in the programming mode move the joystick forward and backward or use the forward button to move through the modes. To change the value of the mode move the joystick left and right or use the right button. Once all options have been set, press the drop button and the game will return to regular game play with the new settings.

MODE EXPLANATIONS MODE "0" GAME TYPE

There are 5 game types:

"0" Left, Right, Forward, Backward, Nudge
This mode is for a control panel that commonly has a joystick and allows the player to lower the claw each time the drop button is pressed. This allows the player to hone in on the prize they are attempting to win. **NOTE:** The crane will position it self according to the operator presets, options 10 and 11, at coin up if option 17 is set to "0" (off). The crane will position it self according to the operator presets, options 10 and 11, at the end of the game option 17 is set to "1" (on).

"1" Left, Right, Forward, Backward, Drop -
This mode is for a control panel that commonly has a joystick and the claw drops fully when the button is pressed. **NOTE:** The crane will position it self according to the operator presets, options 10 and 11, at coin up if option 17 is set to "0" (off). The crane will position it self according to the operator presets, options 100 and 11, at the end of the game option 17 is set to "1" (on).

MODE "1" GAME MODE

There are two game modes:

Normal play – This is the standard type of play where a player has inserted enough coins to create 1 credit and then plays the game. Whether the player wins a prize or not, the game is over.

Play till win – In this mode the player has inserted enough coins to create 1 credit and will be able to play the game until they win a prize.

MODE "2" TIME

This option allows the operator to set the game play length. Options are from 10 seconds to 60 seconds in 5 second intervals.

MODE "3" COIN

This option allows the operator to set the number of coins needed to create 1 credit. A setting of "0" will put the game into free play.

MODE "4" BILL

This option allows the operator to set the number of coins each bill is worth. A setting of "0" turns this option off.

PROGRAMMING

MODE "5" COUNTER TYPE

Setting this option to "0" will have the game count credits on the mechanical and software counters. Setting this option to "1" will have the game count coins.

MODE "6" ATTRACT

This option allows the operator to set the number of minutes between attract modes. Available settings are from 1 minute to 30 minutes in 1 minute intervals.

MODE "7" ATTRACT TYPE

This option allows the operator to choose what type of attract mode they want.

"1" will have an attract mode with movement only.

"2" will have an attract mode with both audio and movement.

MODE "8" MANUAL STRENGTH

This allows the operator to set the strength of the claw for manual percentaging. Available claw strengths are 50-99 with 99 = 100% claw strength.

NOTE: When in this mode the claw will open and close with the strength set in this mode. The operator will be able to feel each strength setting to determine which best suits their needs. When the correct strength setting is determined the operator can just move to the next option, and the manual strength option is set.

MODE "9" AUTO STRENGTH

This option allows the operator to set the claw strength for the auto percentaging mode. Available claw strengths are 50-99 with 99 = 100% claw strength. **NOTE:** When in auto percentaging mode the claw will, at bottoming, close with 100% strength and will then be backed off to the number set in this mode. i.e. With this mode set to 75, the claw will at bottoming close with 100% strength then back off to 75. **NOTE:** The claw will open and close allowing the operator to feel each strength setting to determine which best suits their needs. When the correct setting is determined the operator can just move to the next option, and the auto strength option is set.

MODE "10" RIGHT TIME

This option allows the operator to adjust the time the right motor drive will stay on, for centering purposes at game start up. Available settings are 0-40 intervals of $\frac{1}{4}$ sec. **EXAMPLE:** If this option is set at five, then the right drive motor will stay on for $(5 \times \frac{1}{4} \text{ sec} = 1\frac{1}{4} \text{ sec.})$ $1\frac{1}{4}$ sec. This option is used to correctly center the crane at coin up with different coin speeds and crane sizes. The operator can also use this option along with option 17 to adjust the position of the crane head when the game is over.

MODE "11" FORWARD TIME

This option allows the operator to adjust the time the forward motor drive will stay on, for centering purposes at game start up. Available settings are 0-40 intervals of $\frac{1}{4}$ sec. **EXAMPLE:** If this option is set at five, then the forward drive motor will stay on for $(5 \times \frac{1}{4} \text{ sec} = 1\frac{1}{4} \text{ sec.})$ $1\frac{1}{4}$ sec.

PROGRAMMING

This option is used to correctly center the crane at coin up with different coin speeds and crane sizes. The operator can also use this option along with option 17 to adjust the position of the crane head when the game is over.

MODE "12" PLUSH COST

The operator will use this option to detail the cost of an average piece of plush used in their crane, in terms of the lowest denominator coin used to coin up the game. **EXAMPLE:** If the average cost of a piece of plush is \$1.50 and the lowest denominator coin used to coin up the game is \$0.25 then the number entered for this option will be 6 ($\$1.50 / \$0.25 = 6$). The available plush costs for this option are 1-20.

MODE "13" PAYOUT

The Operator will input the desired payout for the auto percentaging mode. The available percentages for this option are 20% - 50%.

MODE "14" TICKETS TO PLAY

This option is used only if you have a ticket dispenser. In this option the operator has the ability to set the number of tickets that a player will be awarded just for playing the game. The available range is 0-99 tickets.

MODE "15" TICKETS IF LOSE

This option is used only if you have a ticket dispenser. In this option the operator has the ability to set the number of tickets that a player will be awarded when a piece of plush is not won. The available range is 0-99 tickets.

MODE "16" FACTORY DEFAULT

A setting of "0" for this option will keep the latest operator settings. A setting of "1" for this option will restore all options to factory defaults.

MODE "17" CENTERING ON / OFF

This option allows the operator to position the crane any where on the play field. If option 17 is set to "0" (Off) the crane head will position its self at the beginning of the game according to the operator pre sets in options 10 and 11. If option 17 is set to "1" (On) the crane head will position its self at the end of the game according to the operator pre sets in options 10 and 11.

MODE "18" SNAP ON / OFF

This option allows the operator to turn off and on the snap of the claws at the start of the game. If option 18 is set to "0" (Off) the claws will not snap together at the start of a game. If option 18 is set to "1" (On) the claws will snap together at the start of a game.

PROGRAMMING

MODE "19" CREDIT DISCOUNTING

This mode allows the operator to give a free game for multiple CONSECUTIVE credits. In other words, if for example you set a "2" for this option, for every 2 credits IN A ROW that are inserted a free game will be given. The range for this option is 0-5. Setting a "0" turns this option OFF.

MODE "20" UP / DOWN MOTOR TEST

When the operator moves the joystick left and right the claw will raise and lower respectively. The display will change from:

0-1 if the up switch is made
0-2 if the down switch is made
0-3 if both switches are made

MODE "21" LEFT/RIGHT MOTOR TEST

When the joystick is moved left and right the wagon assembly will move to the left and right. The right display will change from:

0-1 if the left home switch is made

MODE "22" FRONT/BACK MOTOR TEST

When the joystick is moved left and right the wagon assembly will move to the forward and backwards. The right display will change from:

0-1 if the back home switch is made

Entering the Accounting Mode

To enter the accounting mode, open the front door and press the button marked ACCOUNT. Located on the main board housing inside the front door. The left displays will flash between "cr" (credits) then the number of credits 1 - 9999. If the operator presses the drop button the displays will flash "pl"(plush), then the number of plush that has passed through the sensor. These numbers can never be reset and WILL NOT match the numbers on the mechanical counters from the counters. It is advisable that the owner, note this difference so that they will be able to track actual software coins/credits and plush out vs. mechanical counters for a counting purposes.

Test Mode Explanation

Every time that the game is powered up, of the door is closed, the game will run through a test mode to check the following items.

- HOME BACK SWITCH
- FRONT/BACK MOTOR
- PRIZE SENSOR
- HOME LEFT SWITCH
- LEFT/RIGHT MOTOR
- OUT OF RANGE
- UP SWITCH
- CREDIT/COIN DISCONNECT
- E² (MEMORY)
- DOWN SWITCH
- CLAW CLOSE, CLAW OPEN

If any of the above items are malfunctioning, the game will light the 4 decimal points on the podium displays. This will alert the operator that there has been a problem. The operator needs only unlock and open the front door and the error codes will be displayed one at a time on the left display. To move to the next error code the operator needs to press the drop button. Repairs should be made to those areas in which errors have been logged. When all codes have been seen

and the door is closed the game will reset error codes, run through a test mode to check for proper operation and if all is well, game play can start, if the 4 decimals will once again light up, the operator will need to check the error codes again. The play can continue to the best of the machines abilities, with problems, until the errors are corrected. At no time should the game be inoperable unless a key component is damaged.

Error code 10/11 will alert the operator that the game has paid out 8 too many or 8 too little pieces pf plush then in auto percentaging. If this error is logged the game will automatically revert to MANUAL settings until one of the following options is changed. (COST OF PLUSH, AUTO % MIN., % PAYOUT, OR GAME COST)

This is why it is imperative that the manual setting be setup before auto percentaging is used.

NOTE: Changing one of these options will reset error code 10/11 and the game will begin auto percentaging with the new settings.

NOTE: Some items on the list can not be detected by the game and require that the operator watches for these actions to be performed during the

Error Codes

- 1 E² (Memory)
- 2 Prize Sensor
- 3 Up Sensor
- 4 Down Sensor
- 5 Left/Right Sensor
- 6 Front/Back Sensor
- 7 Left/Right Motor
- 8 Front/Back Motor
- 9 Counter Disconnect
- 10 Out Of Range (High)
- 11 Out Of Range (Low)

PROGRAMMING

MODE (Credit Display)	DESCRIPTION	MIN / MAX / DEF (Timer Display)	MEANING
BASIC PROGRAMMING			
0	Game Type	0, 4, 0	0—Left, Right, Forward, Backward, Nudge 1—Left, Right, Forward, Backward, Drop
1	Game Mode	0, 1, 0	0—Normal Play 1—Play till you win
2	Time	10, 60, 20	10—60 Seconds (Inc. every 5 seconds)
3	Coin	0, 9, 2	0—Free Play 1—9 Coins required for a single credit
4	Bill	0, 9, 4	0—Off 1—9 Number of coins each bill is worth
5	Counter Type	0, 1, 0	0—Credit counter 1—Coin counter
6	Attract	1, 30, 20	1—30 Minutes between attract modes
7	Attract Type	1, 2, 2	1—Motion only 2—Audio and motion
8	Manual Strength	60, 99, 75	40—99 Claw strength Inc. by 1 (99= MAX)
ADVANCED PROGRAMMING			
9	Auto Skill Leveling Strength	0, 99, 0	0—Auto off 60—99 Claw strength in auto (99 = MAX)
10	Right Time	0, 9, 5	0—40 Number of 1/4 sec. time intervals right
11	Forward Time	0, 40, 5	0—40 Number of 1/4 sec. time intervals forward
12	Plush Cost	1, 20, 4	Coins per piece of plush
13	Payout	20, 50, 33	20—50 Desired payout percentage
14	Tickets to Play	0, 99, 0	0—99 tickets to be paid just to play game
15	Tickets if Lose	0, 99, 0	0—99 tickets to be paid if you do not win plush
16	Factory Default	0, 1, 0	0—Normal 1—Restore factory defaults upon next startup
17	Center On / Off	0, 1, 0	0—Center option off 1—Center option on
18	Snap On / Off	0, 1, 1	0—Snap option off 1—Snap option on
19	Credit Discounting	0, 5, 0	# of Consecutive credits inserted for 1 free game
20	Up / Down Motor Test	DIAG.	Right display changes: 0—1 Up switch is made 0 – 2 Down switch is made 0 – 3 Both switches are made
21	Left / Right Motor Test	DIAG.	Right display changes: 0 – 1 Left switch is made
22	Front / Back Motor Test	DIAG.	Right display changes: 0 – 1 Back switch is made 0 – 2 Front switch is made

MANUAL SETUP / PERCENTAGING

OVERVIEW

Although our crane offers the option of being able to be set up for MANUAL or AUTOMATIC PERCENTAGING modes, many operators prefer to use the MANUAL percentaging mode for a number of reasons.

NOTE: THE FOLLOWING INFORMATION IS NOT APPLICABLE TO CANDY CRANES. CANDY CRANES ARE GENERALLY SET UP AS PAY 'TILL YOU WIN AND ARE NORMALLY SET UP FOR THE SHOVEL OR SCOOP TO GRAB AS STRONGLY AS POSSIBLE.

When Manually percentaging your cranes, ALL of the following factors may affect your payout:

- Claw open position
- Claw closed position
- Claw Slider positioning
- Claw shape
- Claw Strength
- Size and Texture of the Plush
- Packing of the Plush
- Type of Customer

Basic EXPERIENCE and EXPERIMENTATION will determine the best set-up for you. Our cranes offer all of the popular adjustment options, so you can easily set your crane up to work just as any other cranes you may have previously used.

The above mentioned factors are described in greater detail below. We will review all of these in detail, so you will know better how to set up your game.

NOTE: IF YOU ALREADY KNOW HOW ALL OF THE ABOVE MENTIONED FACTORS AFFECT YOUR EARNINGS, YOU MAY PROCEED TO THE **SETUP SECTION.**

CLAW OPEN POSITION

The CLAW OPEN POSITION is determined by how you set the adjustable washer that is located under the solenoid plunger. This should be adjusted so that the claw will go around one plush prize, but will not go around more than one. This is important so you can limit the payout and more accurately keep track of your prize count (if you have a prize sensor). It is especially important to adjust the claw open position if you use small or beanie type prizes. If the claw opening is too large, you could pick up multiple prizes at once very easily.

This open position can be easily changed by ROTATING the "Saw Blade" shaped cam washer located just under the solenoid plunger. Loosen the Allen head bolt under the claw assembly, rotate the washer until the claw open position what you want, then re-tighten the Allen bolt.

CLAW CLOSED POSITION

The CLAW CLOSED POSITION is important for determining the OVERALL grab or "appearance" of grab of the claw. Normally, the claw closed position is set so that when the solenoid is engaged, the claw appears to close fully. For the most part, the prizes are big enough that the tips of the claw can be set up to be slightly apart when the solenoid is energized. Normally you do not want the tips to bang together as they can lock into each other if they overlap too far, then even when the solenoid releases, the claw tips are stuck together. For this reason we generally recommend that you keep about a "dime" sized space between the claws when they are closed. Of course you can also adjust this opening size to anything you would like.

To adjust the claw closed position, loosen the bottom collar on the solenoid housing, and raise

MANUAL SETUP / PERCENTAGING

or lower the position of the collar to adjust the closed position of the claws. Push the solenoid plunger in by hand to verify the claw position and re-tighten the collar.

CLAW SLIDER POSITIONING

The job of the CLAW SLIDER is to determine the ACTUAL grab of the claw. This actual grab however, will change based on where the claw contacts the plush. This change is what actually makes the game exciting to the customers and allows for more challenging game play.

The slider will move up and allow the claw to open whenever there is lateral (side to side) pressure exerted on the claw tips. When the pressure is removed the claw instantly returns to the closed position.

Since the lateral (side to side) pressure against the claw tips is what allows the slider to function, the shape of the claw will influence how easily the slider will work. (For more on claw shape, read the claw shape section of the manual).

The claw slider is adjusted by the position of the upper collar on the solenoid body. If you set the collar against the slider, it will not function at all. This effectively locks the slider out. This is "usually" what is done for the auto-percentaging mode.

If the collar is adjusted for a larger gap, the claw will open further. The bigger the gap, the more the claw grab is actually limited.

You may wish to adjust the slider so that a grab of an arm, leg or hand will not work, but a grab of the body will.

You may wish to set the slider so that even a body grab won't work, but a grab across the body and shoulder will.

NOTE: THIS ADJUSTMENT HAS THE MOST IMPACT ON YOUR PERCENTAGING. ALLOWING THE SLIDER MORE OR LESS MOVEMENT WILL CHANGE YOUR OVER-ALL PAYOUT PERCENTAGE.

Play around with the upper collar positioning to get an idea of how this adjustment works.

CLAW SHAPE

CLAW SHAPE will determine how easily the plush is grabbed. A rounder shape will "cradle" the plush more making it easier to pick up plush. You will want to use this shape (see illustration) if you have large or heavy plush and are having a difficult time dispensing enough product.

On the other hand, if the game consistently pays out too much, you may wish to change the shape of the claw if none of your other adjustments will percentage the game properly. You will want to bend the claws into more of a "HEART" shape. (See illustration) This will allow the plush to slide more easily through the claws.

CLAW STRENGTH

CLAW STRENGTH can also be used to fine tune your payout percentages. By increasing claw strength from lowest power (40) to (99) highest you can adjust the strength of the solenoid. You will normally want to keep your claw strength between 80-99 unless you are using very light prizes.

SIZE AND TEXTURE OF PLUSH

The size and texture of plush will had a dramatic impact on how your game pays out.

Under normal circumstances, the closer you can keep the prizes to having the same general size and weight, the easier it will be to get consistent payouts. While it is sometimes necessary to mix

MANUAL SETUP / PERCENTAGING

different size prizes, please be aware that this will affect your payout to some extent.

The biggest issue with plush size will be adjusting the slider to compensate for the different sizes.

Texture of the plush can affect payouts as well. Vinyl toys will stick and grab the claws differently than fur covered toys that will slide through more easily.

PACKING OF THE PLUSH

How you "pack" the plush will have a big impact on how your game pays out. Some people prefer to tightly pack the plush to keep the payout lower. This works fine until a few prizes are won and then it becomes much easier to win. We suggest a loose pack as it is much easier to be consistent with, and much easier to percentage.

TYPE OF CUSTOMER

Lastly, don't forget the type of customer at your location will be a determining factor. You may need to make adjustments just for this.

SETTING UP YOUR MACHINE MANUALLY

PLEASE READ THIS SECTION CAREFULLY TO GET THE BEST POSSIBLE RESULTS FROM YOUR MACHINE

In this section we will give you an example of how you might like to set your machine up.

As you become more familiar with this machine, you may be able to eliminate some steps.

CALCULATIONS

The best way to set up your crane manually is to test it in house over a number of games.

We suggest testing in 100 game increments to get the best idea of an accurate payout. Once you become familiar with your crane and your prizes, you may not need to test as extensively in house. Of course, you could bypass this entire step, but you might get undesirable results in the field.

Use the following example to figure out your PAYOUT using the following example.

Let's say your game costs 50 cents to play, you want to pay out 33 percent, and your plush cost is \$2.50.

First, if you play 100 games at 50 cents you need to figure out what is 33 percent of 100 games at 50 cents.

Calculate $100 \times .50$ (50 cents). This equals \$50.00.

Next Calculate $\$50.00 \times .33$ which is 33 percent. Your result will be \$16.50.

Next, divide the \$16.50 by the value of your plush which in this case is \$2.50. The answer is 6.6 This would mean that for each 100 games you play, you would want to pay out approximately 6.6 prizes.

Let's do the same calculations again with different beginning values...

Let's say your game costs 25 cents to play, you want to pay out 20 percent, and your plush cost is \$1.50

First, if you play 100 games at 25 cents you need to figure out what is 20 percent of 100 games at 25 cents.

MANUAL SETUP / PERCENTAGING

Calculate $100 \times .25$ (25 cents). This equals \$25.00.

Next Calculate $\$25.00 \times .20$ which is 20 percent. Your result will be \$5.00

Next, divide the \$5.00 by the value of your plush which in this case is \$1.50. The answer is 3.3 This would mean that for each 100 games you play, you would want to pay out approximately 3.3 prizes.

INITIAL ADJUSTMENT

Set your game up as follows before testing:

Claw Open Position - Leave stock from the factory unless the open position is too small to go around the plush prizes.

Claw Closed Position - Leave an opening about the size of a dime when claws are closed. This will prevent the claw tips from overlapping which could cause the claw tips to stick together.

Claw Slider Position - The initial setting of the slider should be set so that if the claw tips grab onto an arm or leg of the plush the claws will slip off. This only applies when the tips grab onto the plush from the side.

NOTE: WHEN THE CLAW TIPS ARE UNDER THE PRIZE THE SLIDER WILL HAVE VERY LITTLE EFFECT UNLESS THE CLAW SHAPE HAS BEEN CHANGES NOTICEABLY.

Loosen the top collar or cap located on top of the slider and raise or lower to allow greater or lesser effect from the slider.

Claw Shape - do not change at this time.

Claw Strength - Set the initial strength value to "70"

FINAL ADJUSTMENT

After playing 100 games check to see what your payout is at. Use the adjustments to change the percentages. Since there are so many different ways and preferences by the customers to raise or lower payouts, please feel free to experiment with different ways. The information at the beginning of this section details all of the possible adjustments and their affects on the game.

Retry until you are comfortable that you have a good initial set-up for the street.

You will find that various locations will payout differently just because of the types of players that frequent the locations.

You will also find that the plush can have a big impact on the payout percentages.

HINTS FOR CONSISTENT PAYOUTS

1. Find an adjustment method that works good and stick with it for all of your ICE cranes.
2. Try to keep the plush size and type as consistent as possible within the machine.
3. Try to write down settings for certain types of plush.

EXAMPLE: When you put in the "Valentines Day or Christmas" mix, write down those settings so you can set your crane up the same way the next time you put that particular mix into the machine. Also, if you have a lot of locations, you can just tell your route man how to set up the cranes for that particular type of plush.

Problem	Probable Cause	Solution
The decimals on the 4 displays are lit up.	This is in fact not a problem but a way of letting the operator know that there was a problem during the startup mode.	Open the front door and the error codes are shown on the displays. To advance through the error codes, press the fire button.
No game power.	On-Off switch on the game is turned off? Blown AC power fuse? Game not plugged in or cord is damaged? Bad transformer? Transformer harness not connected? Bad power module?	Turn Power on. Replace with proper fuse. Check power cord. Check for proper voltages Check harness. Replace power module.
Game will not take money or give credits correctly.	Bad coin switch? Coin discounting set wrong? Coin per credit setting incorrect? Bad Coin mechanism? Loose or damaged harnessing? Bad main PCB circuit board?	Check w/ Ohm meter and replace. Check programmable setting. Check programmable setting. Adjust or replace. Check w/ Ohm meter and repair. Repair or replace main board.
Displays do not work.	Bad 12v fuse? Bad display PCB circuit board? Bad main PCB circuit board? Loose or damaged display harnessing?	Replace with proper fuse. Repair or replace PCB circuit board. Repair or replace PCB circuit board. Check w/Ohm meter and repair.
Crane or wagon doesn't move.	Bad motor? Loose or damaged harnessing? Bad switch on button or joystick? Bad harnessing to buttons or joystick? Blown fuse to motors on main PCB circuit board. Broken drive belt?	Replace motor. Check w/Ohm meter and repair. Replace switch. Check w/Ohm meter and repair. Replace with proper fuse. Replace broken belt.
Crane keeps trying to move in the home position.	Bad limit switches? Limit switch not aligned with actuator?	Replace Switches. Align switch and actuator.
Claw will not close.	Blown fuse to claw on main PCB circuit board? Bad coil? Loose or damaged harnessing? Claw has mechanically jammed?	Replace with proper fuse. Replace coil. Check w/Ohm meter and repair. Find jam and repair.
Claw stays closed.	Bad drive transistor on main PCB circuit board? Claw has mechanically locked?	Replace transistor. Find jam and repair.
Auto precentageing is not functioning.	Programming is not correctly set? Bad prize sensor? Loose or damaged sensor harness?	Set option 9 and 16. Replace prize sensor. Check w/Ohm meter and repair.
Claw goes down and then up but doesn't close.	Down switch is bad? Loose or damaged harness to down switch?	Replace down switch. Check w/Ohm meter and replace.
Claw comes up and about 15 seconds passes before crane moves to the home position.	Up switch is bad? Loose or damaged harness to the up switch?	Replace up switch. Check w/Ohm meter and replace.
Crane or wagon wheels slip.	Missing or damaged o-ring drive belts? Loose set screws in wheels? Loose set screws in drive coupler? Rails need to be scuffed?	Replace o-ring belts. Tighten set screws. Tighten set screws. Scuff top of rails with sandpaper.

QUICK TROUBLESHOOTING

A self-test will be performed each time the front door is “closed” or the game is powered up.

If the Wagon does not move smoothly through a full travel from left to right, check to see that the wheel spacing is correct. If the spacing is correct then check the 2 cabinet rails for burrs that may cause the wheels to bind. Also check for broken or loose drive belts.

If the Wagon does not move smoothly through a full travel from front to back, check to see that the rod bushings are straight and not binding. Check for excessively loose drive belts or one of them broken.

If the front door is having trouble closing fully, check to see that the front door harness is routed properly. Also be sure the prize door is fully shut. If it is partially open it will not allow the front door to open or close properly.

If the door will not lock properly or locks with difficulty, check to see if the lock rotates smoothly. Next check that the lock rods are not binding on the lock cam or the lock rod guides. Next check that all friction points have been lubricated with molly grease. Finally if need be, file the lock rod guides such that the door closes and locks smoothly but be careful not to file out too much, for this may cause the door not to pull tightly to the cabinet as it was intended to do.

If the decimals light up on the displays after a self-test, an error has been locked. To advance through the error codes press the drop button when in error detection mode.

If, at the beginning of the self-test mode, the claw does not drop, one or more of the following may apply. The prize sensor is not working, or blocked. The string or string lever is mechanically binding. The up or down switch is sticking or misaligned from its actuator.

If claw stays closed it is likely that the diode has blown and the transistor controlling the claw has also blown. Shut off the game immediately and have a new diode, in coil assembly, and transistor, on main board, installed.

If claw is jerky while being lowered, it is likely that the string has mechanically bound on the spool. To fix the string binding enter programming mode and go to CLAW UP/DOWN MODE. By moving the joystick to the left and right you are able to raise and lower the claw mechanism. Move the crane over the prize chute and lower the claw mechanism all the way until it starts to wind up backwards. Reverse the motor direction to raise the claw mechanism and properly rewind the string on the spool. Exit the programming mode and the string should be free of mechanical binding.

If the claw stays open First check for bad fuses on the main board, next check that there are no wires dislodged from the connectors in the harness between the wagon and the crane, the harness between the wagon and the main board, the crane assembly and the wagon assembly. If the problem still exists and no fuses are blown or wires dislodged it is likely that the transistor controlling the voltage to the claw has blown on the main board. Replace main board and have the other main board repaired by electronics.

If the crane/wagon in the home position still tries to move left or back, check to see that the actuators are both present. Check to see that the sensors are present. Next check to see that the sensors and the actuators are both aligned. Then check to see that the sensor wires are not dislodged from the connectors. Finally replace the sensor; it is likely to be bad.

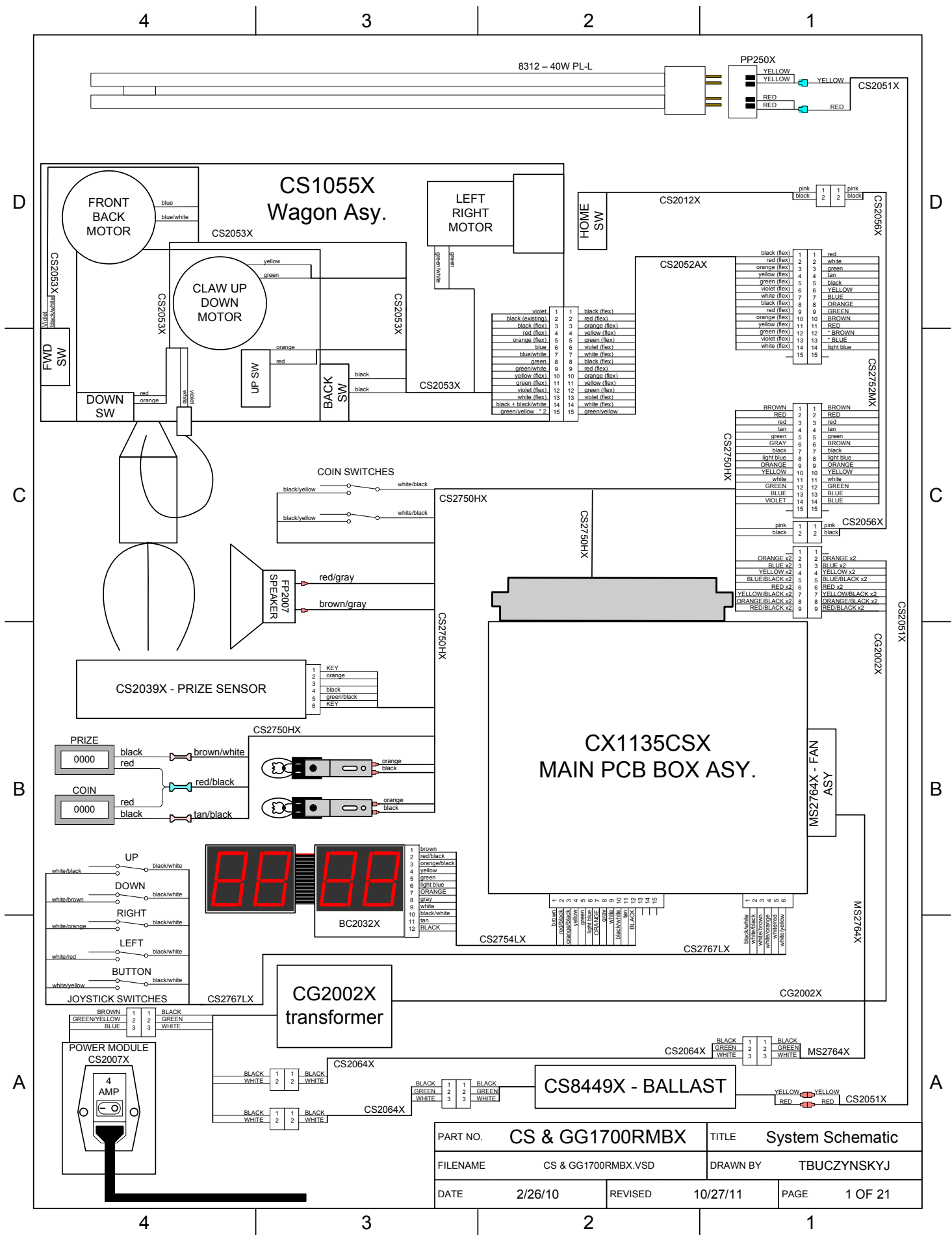

PART NO.	CS & GG1700RMBX	TITLE	System Schematic
FILENAME	CS & GG1700RMBX.VSD	DRAWN BY	TBUCZYNSKYJ
DATE	2/26/10	REVISED	10/27/11
		PAGE	1 OF 21

D

D

C

C

B

B

A

A

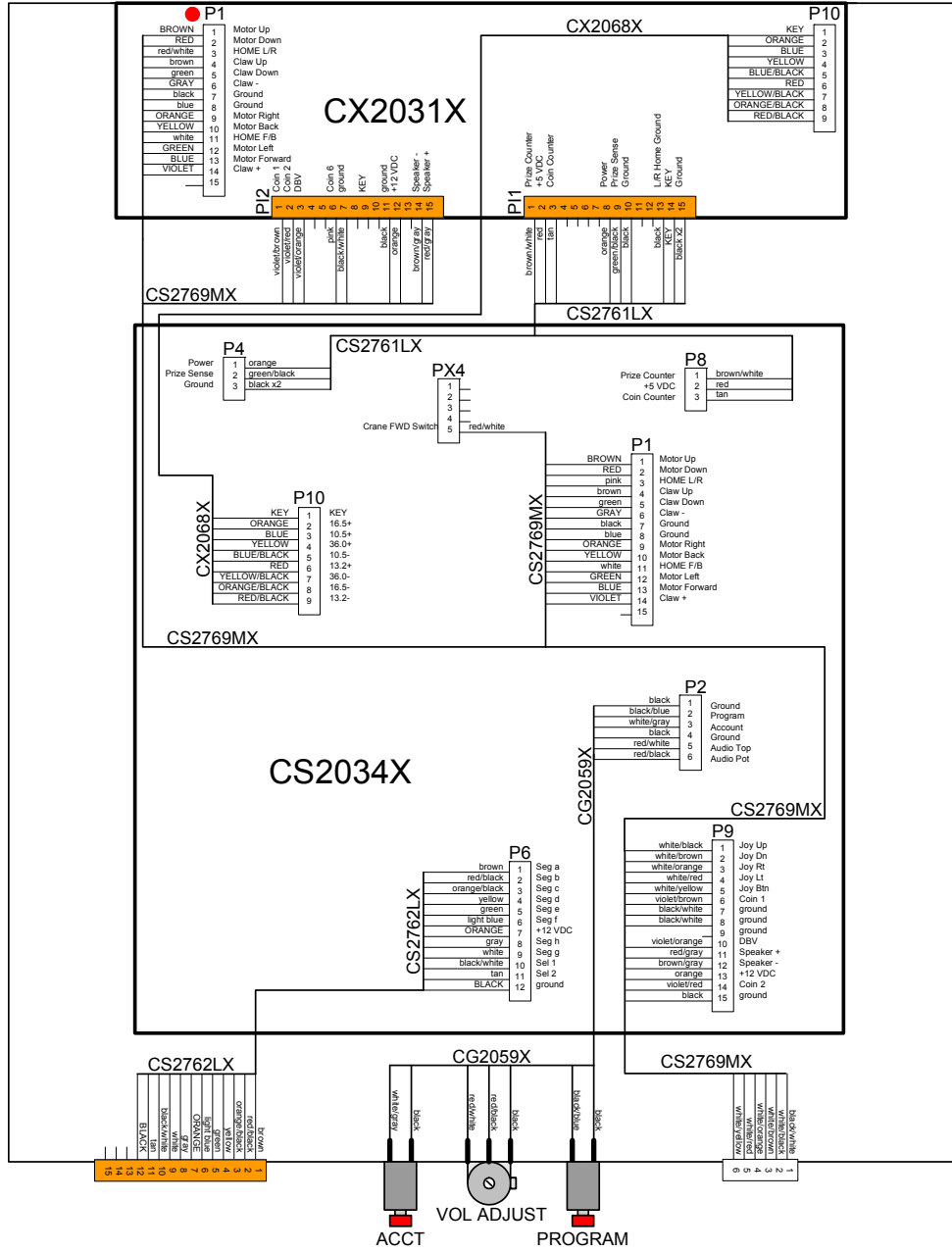

PART NO.	CX1135CSX	TITLE	RMB SCHEMATIC
FILENAME	CS & GG1700RMBX.VSD	DRAWN BY	TBUCZYNSKYJ
DATE	2/26/10	REVISED	10/27/11
		PAGE	2 OF 21

4 3 2 1

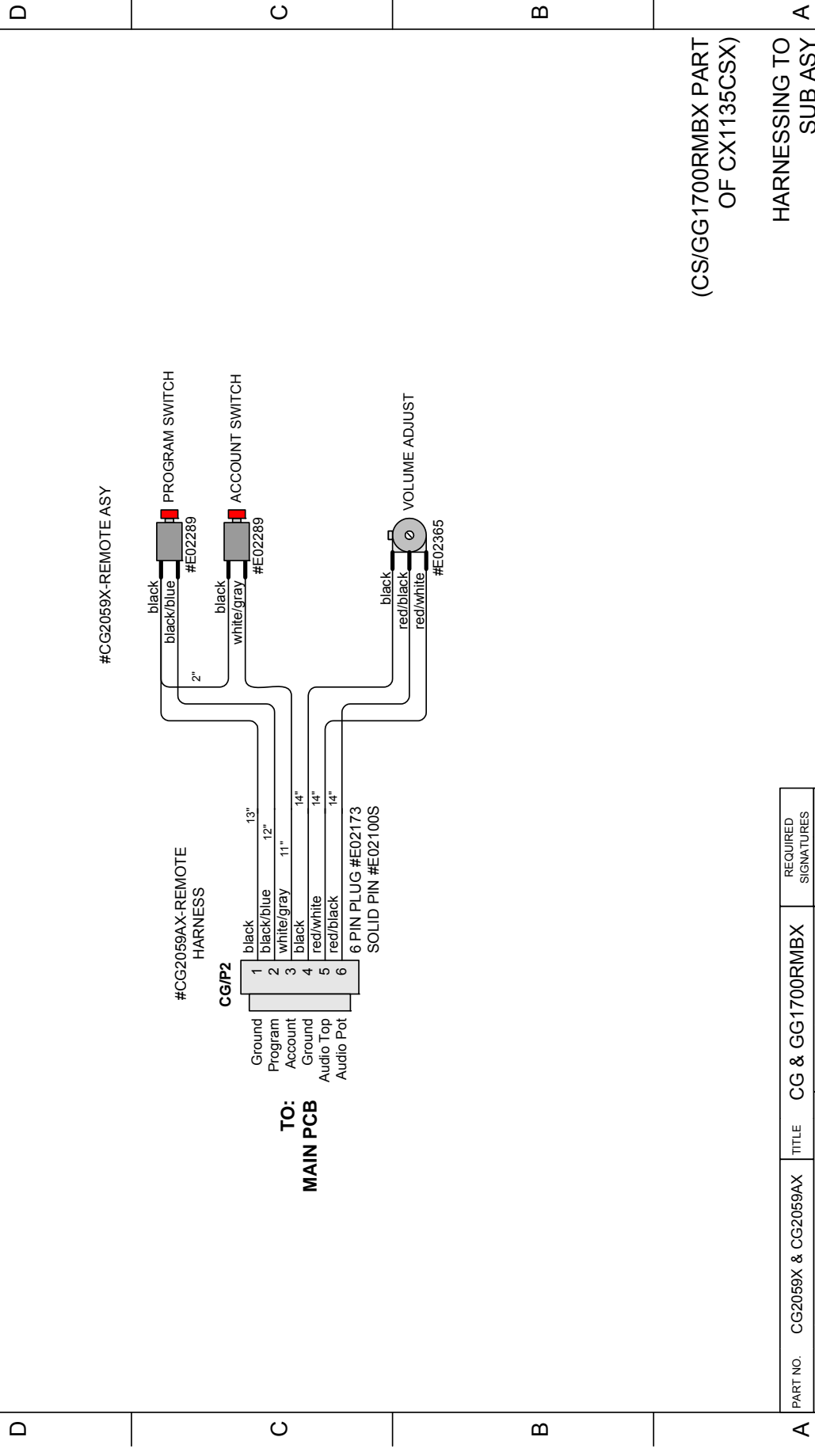

(CS/GG1700RMBX PART OF CX1135CSX)

HARNESSING TO SUB ASY
SUB ASY TO PUT ON ZIP TIES

1

2

3

4

PART NO.	CG2059X & CG2059AX	TITLE	CG & GG1700RMBX	REQUIRED SIGNATURES
DESCRIPTION	CG2059X - REMOTE ASY CG2059AX - REMOTE HARNESS	FILENAME	CS & GG1700RMBX.VSD	ENGINEER
DATE	2/26/10	REVISED	10/27/11	MANAGER
		PAGE	3 OF 21	VENDOR

4 3 2 1

#E00038 - FUSE MDQ-4 4AMP SLO-BLO
 #E02892 - POWER MODULE CORCOM PELS0SSX0

TIME DELAY FUSE
 #7077 DECAL - TIME DELAY FUSE

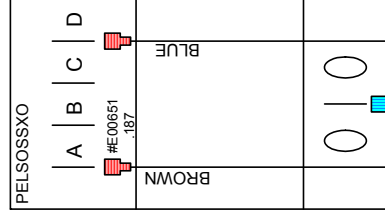

#CC3007 - WORKBOX (SINGLE)
 #RC1001 - BRACKET (POWER MODULE)

CS2055X - HARNESS
 POWER MOD

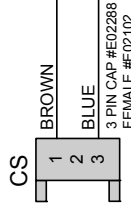

12" BROWN
 12" BLUE
 25" GREEN/YELLOW

To Transformer

To Bracket

SEE CS2707X
 220 V - 2 AMP FUSE E02062

PART NO.	CS2007X & CS2055X	TITLE	CG & GG1700RMBX	REQUIRED SIGNATURES
DESCRIPTION	CS2007X - POWER MOD ASY CS2055X HARNESS	FILENAME	CS & GG1700RMBX.VSD	ENGINEER
DATE	2/26/10	REVISED	10/27/11	MANAGER
		PAGE	4 OF 21	VENDOR

4 3 2 1

4 3 2 1

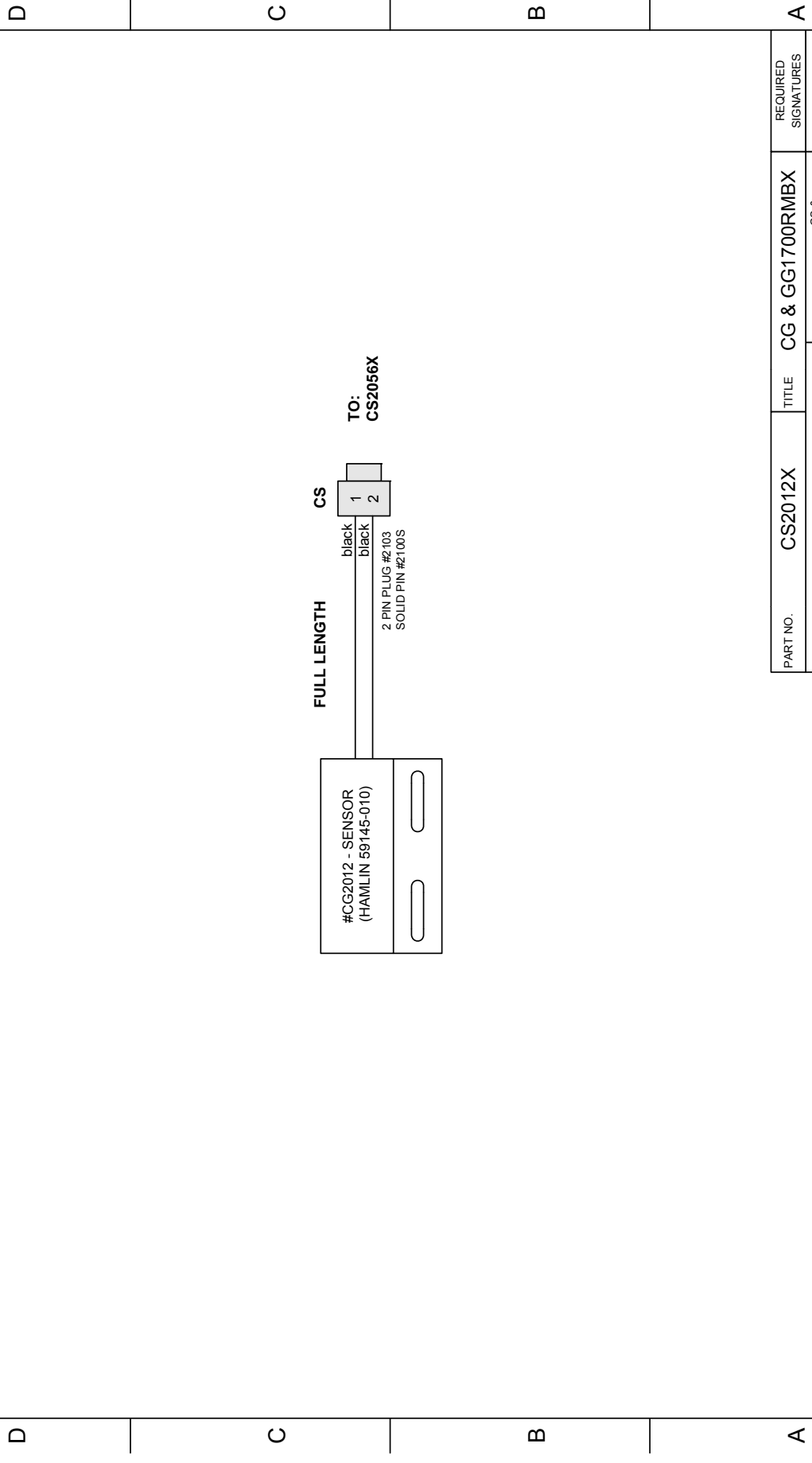

PART NO.	CS2012X	TITLE	CG & GG1700RMBX	REQUIRED SIGNATURES
DESCRIPTION	SENSOR ASY.		FILENAME	ENGINEER
DATE	2/26/10	REVISED	GG1700RMBX.VSD	MANAGER
			DRAWN BY	VENDOR
			TBUCZYNSKYJ	
			PAGE	
			5 OF 21	

SUB ASY

4 3 2 1

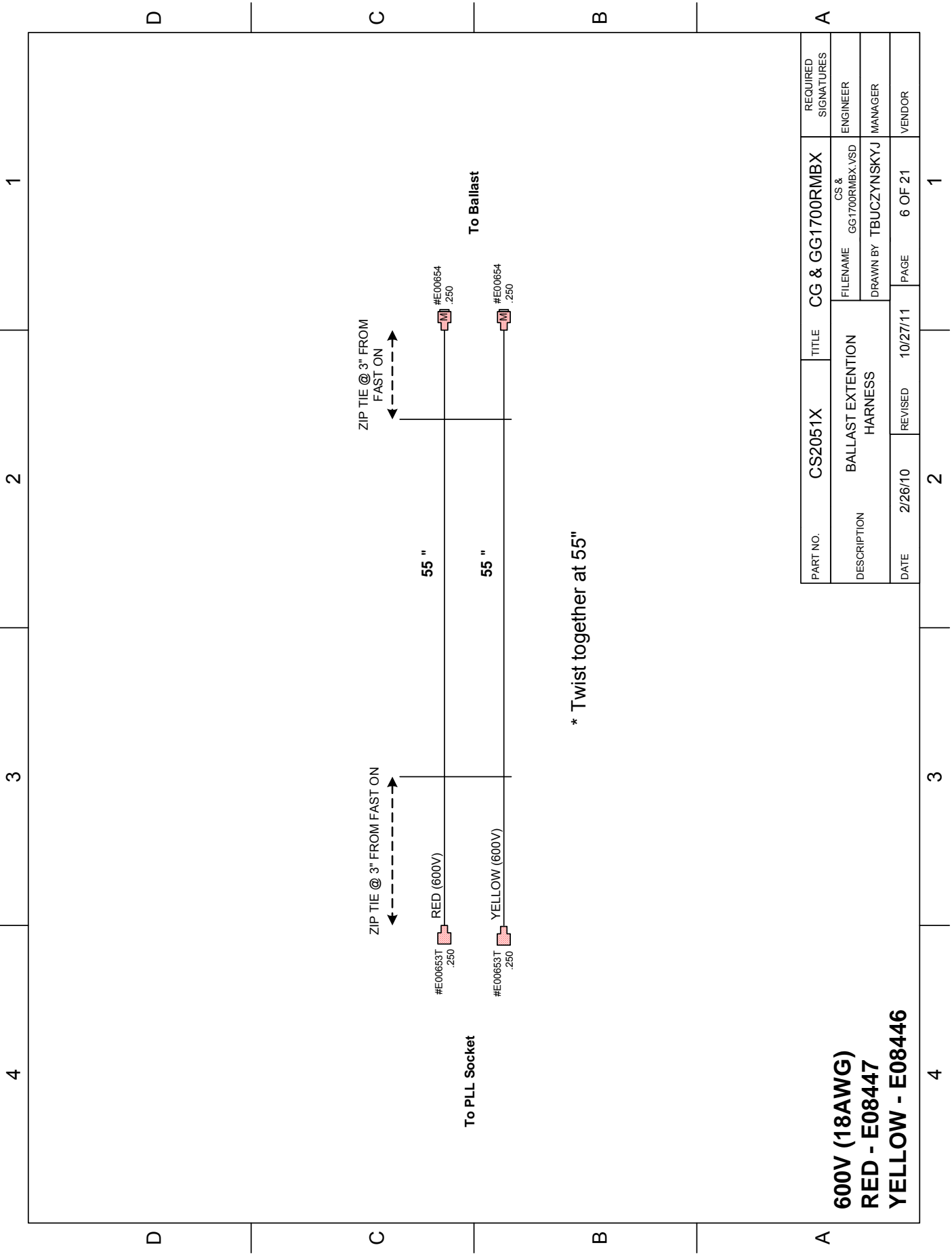

* Twist together at 55"

**600V (18AWG)
RED - E08447
YELLOW - E08446**

PART NO.	CS2051X	TITLE	CG & GG1700RMBX		REQUIRED SIGNATURES
DESCRIPTION	BALLAST EXTENTION HARNESS		FILENAME	CS & GG1700RMBX.VSD	ENGINEER
DATE	2/26/10	REVISED	10/27/11	DRAWN BY	TBUCZYNSKYJ
				PAGE	6 OF 21
					VENDOR

1 2 3 4

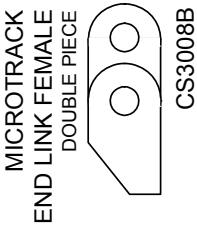
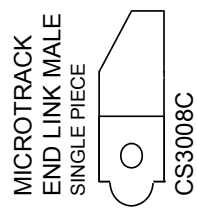

LENGTH OF
TRACKING
@ 39 PIECES -
CS3008A

31"

FLEX
END

RIGID
END

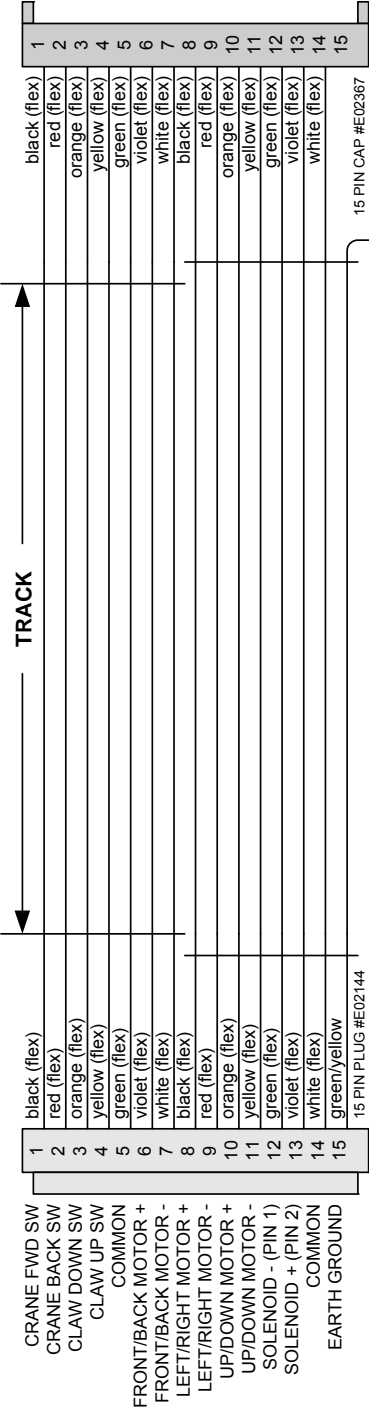

A-7 ON PIN MACHINE

FLEX WIRES
CUT WIRES @ 32"
THEN, LIGHT TWIST TO 31"

A-7 ON PIN MACHINE

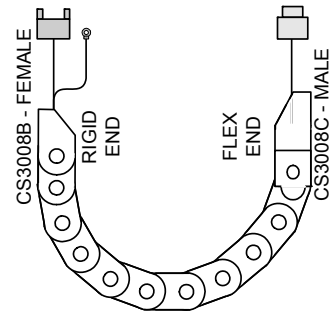

PART NO.	CS2052AX	TITLE	CG & GG1700RMBX	REQUIRED SIGNATURES
DESCRIPTION	MAIN TO WAGON UPPER HARNESS	FILENAME	GG1700RMBX.VSD	ENGINEER
DATE	2/26/10	REVISED	10/27/11	MANAGER
		PAGE	7 OF 21	VENDOR

1 2 3 4

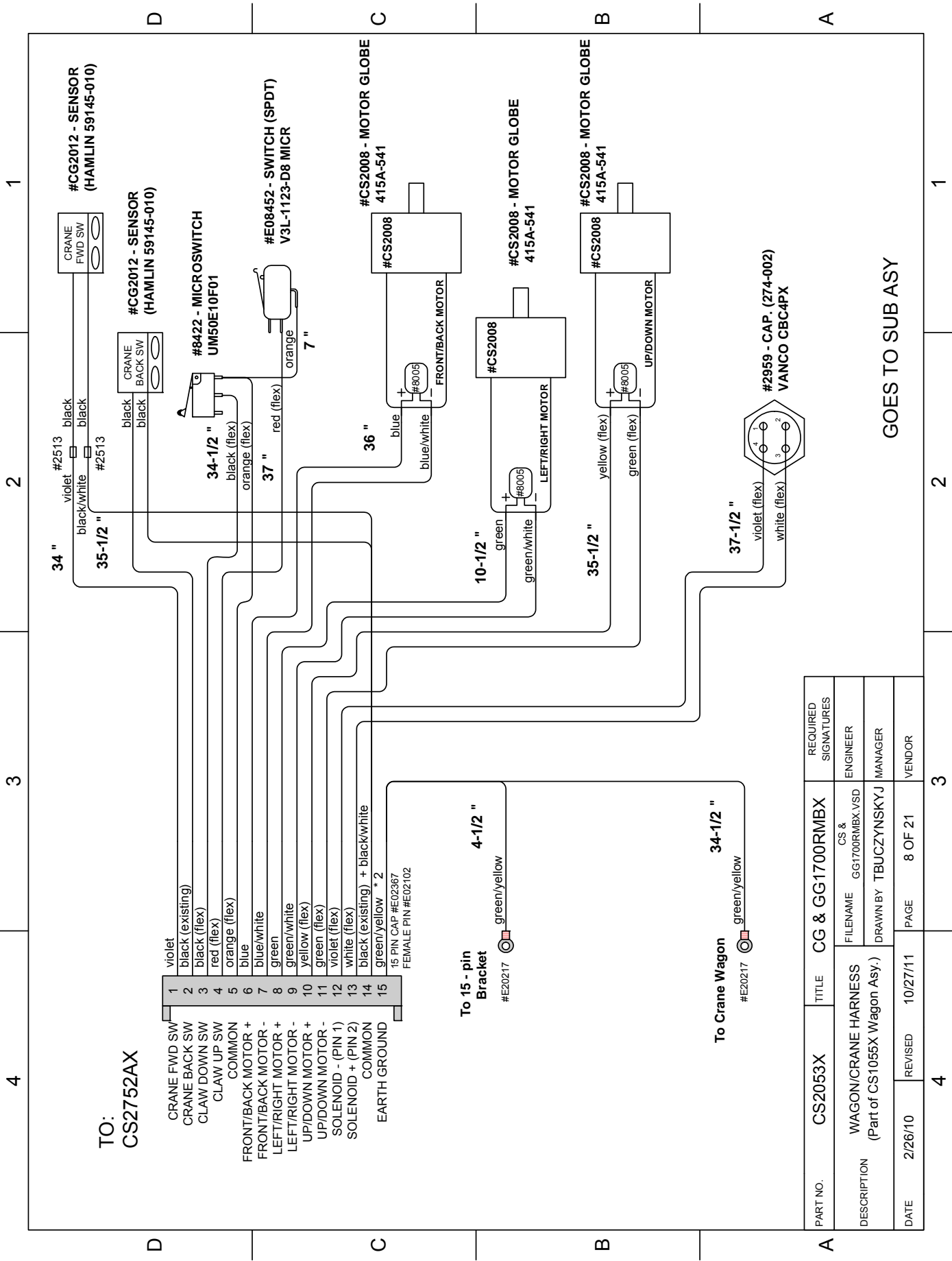

TO:
CS2752AX

- 1 violet
- 2 black (existing)
- 3 black (flex)
- 4 red (flex)
- 5 orange (flex)
- 6 blue
- 7 blue/white
- 8 green
- 9 green/white
- 10 yellow (flex)
- 11 green (flex)
- 12 violet (flex)
- 13 white (flex)
- 14 black (existing) + black/white
- 15 green/yellow * 2

To 15 - pin
Bracket
#E20217 green/yellow

To Crane Wagon
#E20217 green/yellow

PART NO.	CS2053X	TITLE	CG & GG1700RMBX	REQUIRED SIGNATURES
DESCRIPTION	WAGON/CRANE HARNESS (Part of CS1055X Wagon Assy.)	FILENAME	CS & GG1700RMBX.VSD	ENGINEER
DATE	2/26/10	DRAWN BY	TBUCZYNSKYJ	MANAGER
REVISED	10/27/11	PAGE	8 OF 21	VENDOR

GOES TO SUB ASY

1 2 3 4

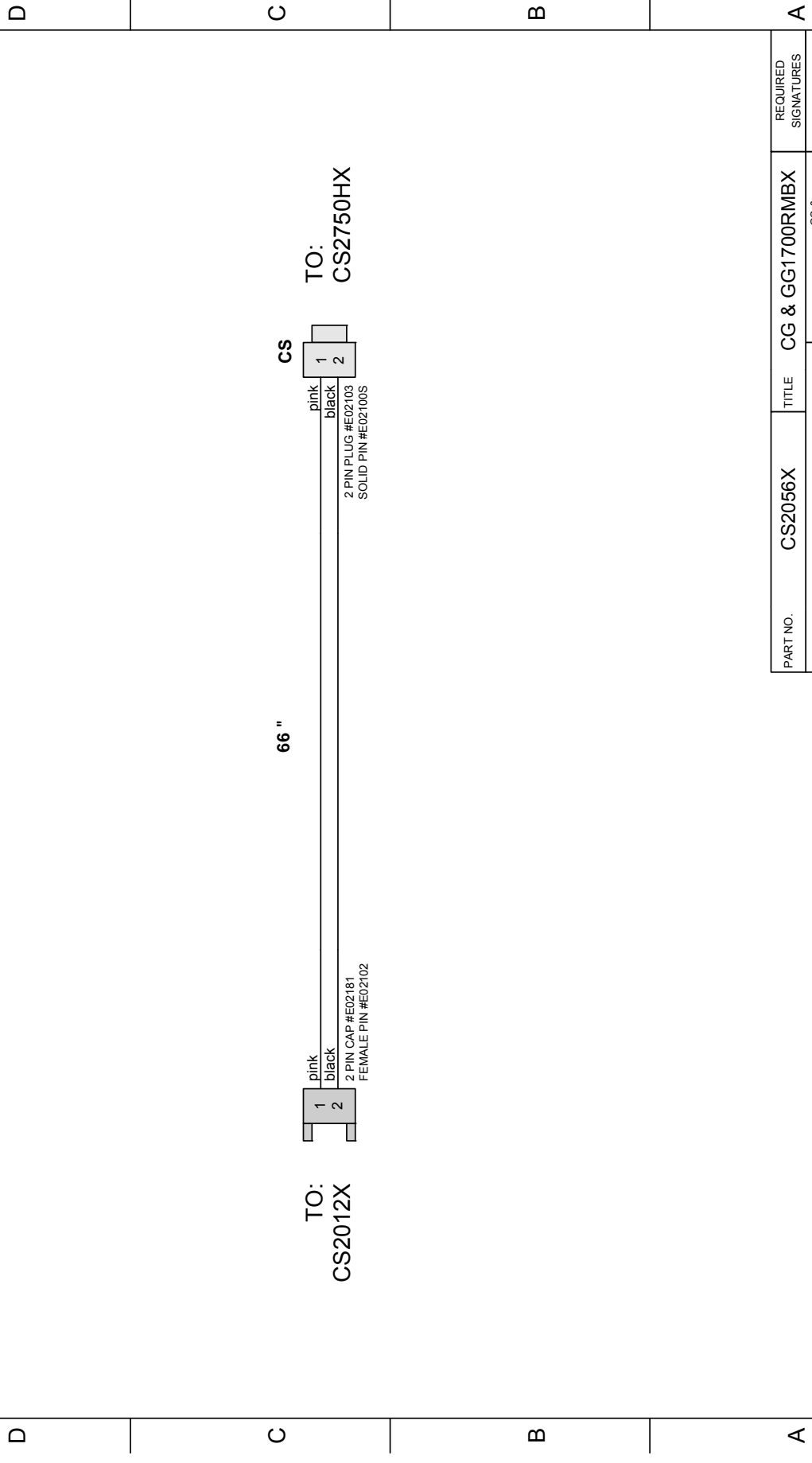

PART NO.	CS2056X	TITLE	CG & GG1700RIMBX	REQUIRED SIGNATURES
DESCRIPTION	SENSOR EXTENTION HARNESS		FILENAME	CS & GG1700RIMBX.VSD
DATE	2/26/10	REVISED	DRAWN BY	TBUCZYNSKYJ
			PAGE	9 OF 21
				VENDOR

1 2 3 4

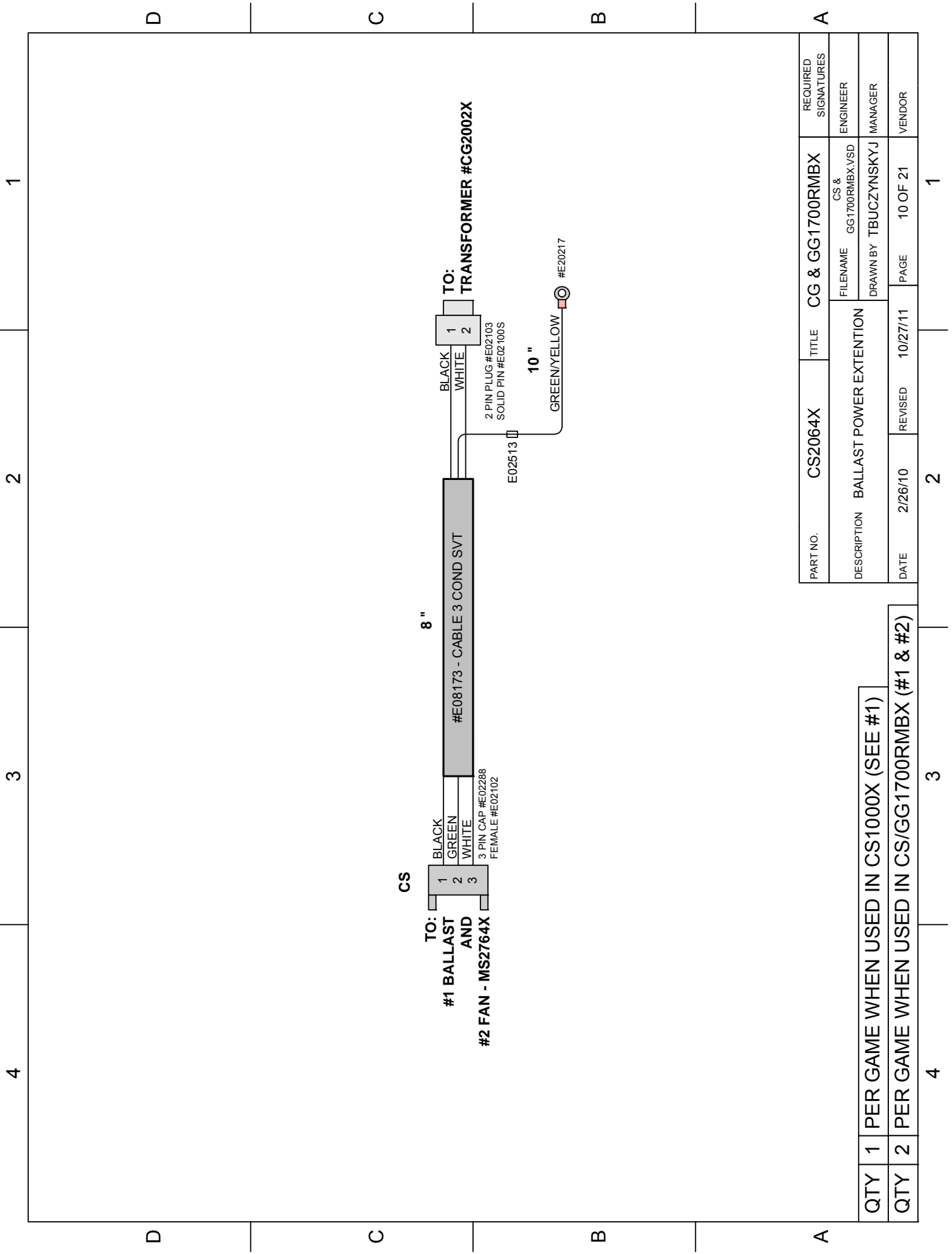

QTY	1	PER GAME WHEN USED IN CS1000X (SEE #1)
QTY	2	PER GAME WHEN USED IN CS/GG1700RMBX (#1 & #2)

PART NO.	CS2064X	TITLE	CG & GG1700RMBX	REQUIRED SIGNATURES
DESCRIPTION	BALLAST POWER EXTENSION	FILENAME	CS & GG1700RMBX.VSD	ENGINEER
DATE	2/26/10	REVISED	10/27/11	MANAGER
			PAGE	VENDOR
			10 OF 21	

4 3 2 1

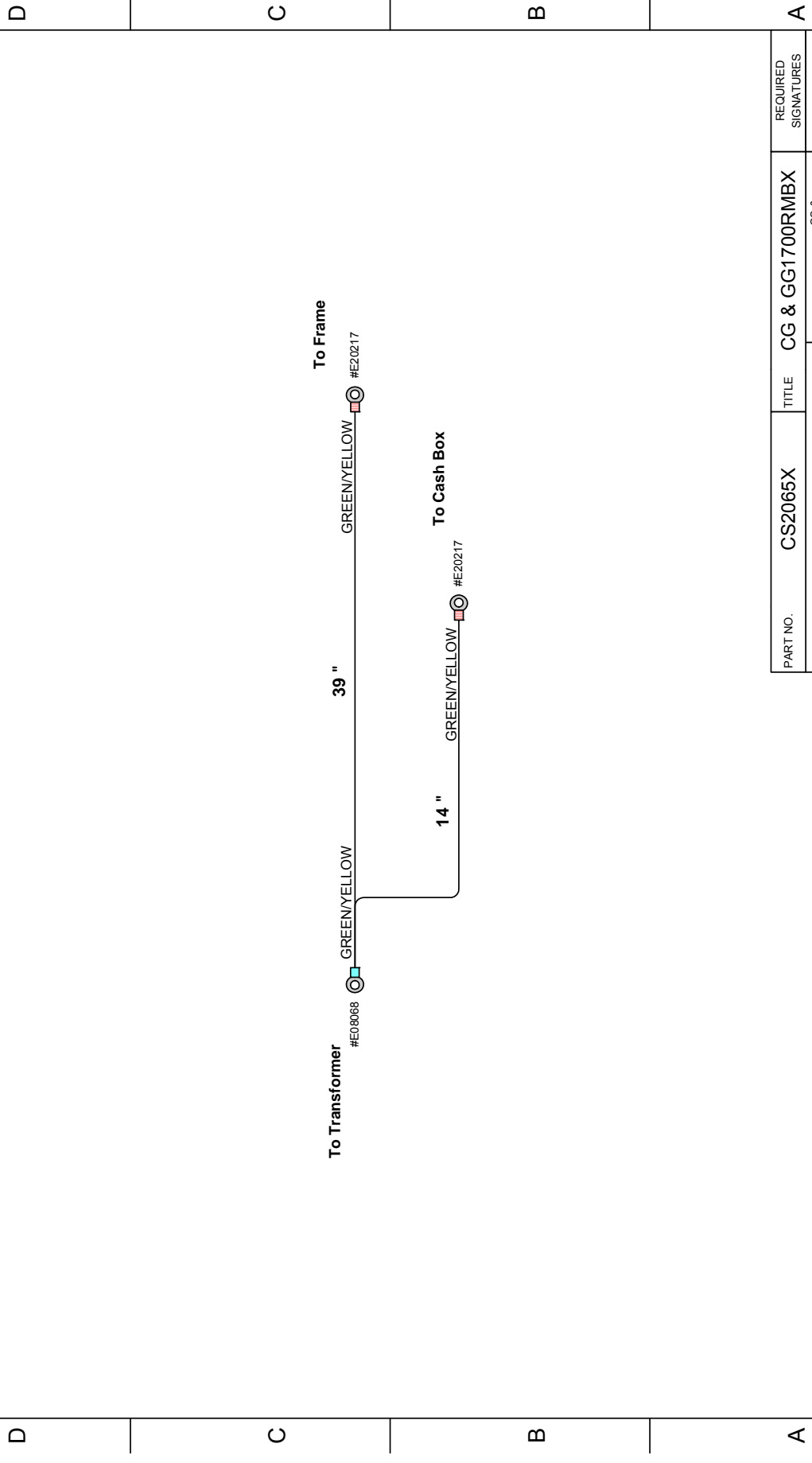

PART NO.	CS2065X	TITLE	CG & GG1700RIMBX	REQUIRED SIGNATURES
DESCRIPTION	FRAME GROUND HARNESS	FILENAME	CS & GG1700RIMBX.VSD	ENGINEER
DATE	2/26/10	DRAWN BY	TBUCZYNSKYJ	MANAGER
		REVISED	10/27/11	PAGE 11 OF 21
				VENDOR

4 3 2 1

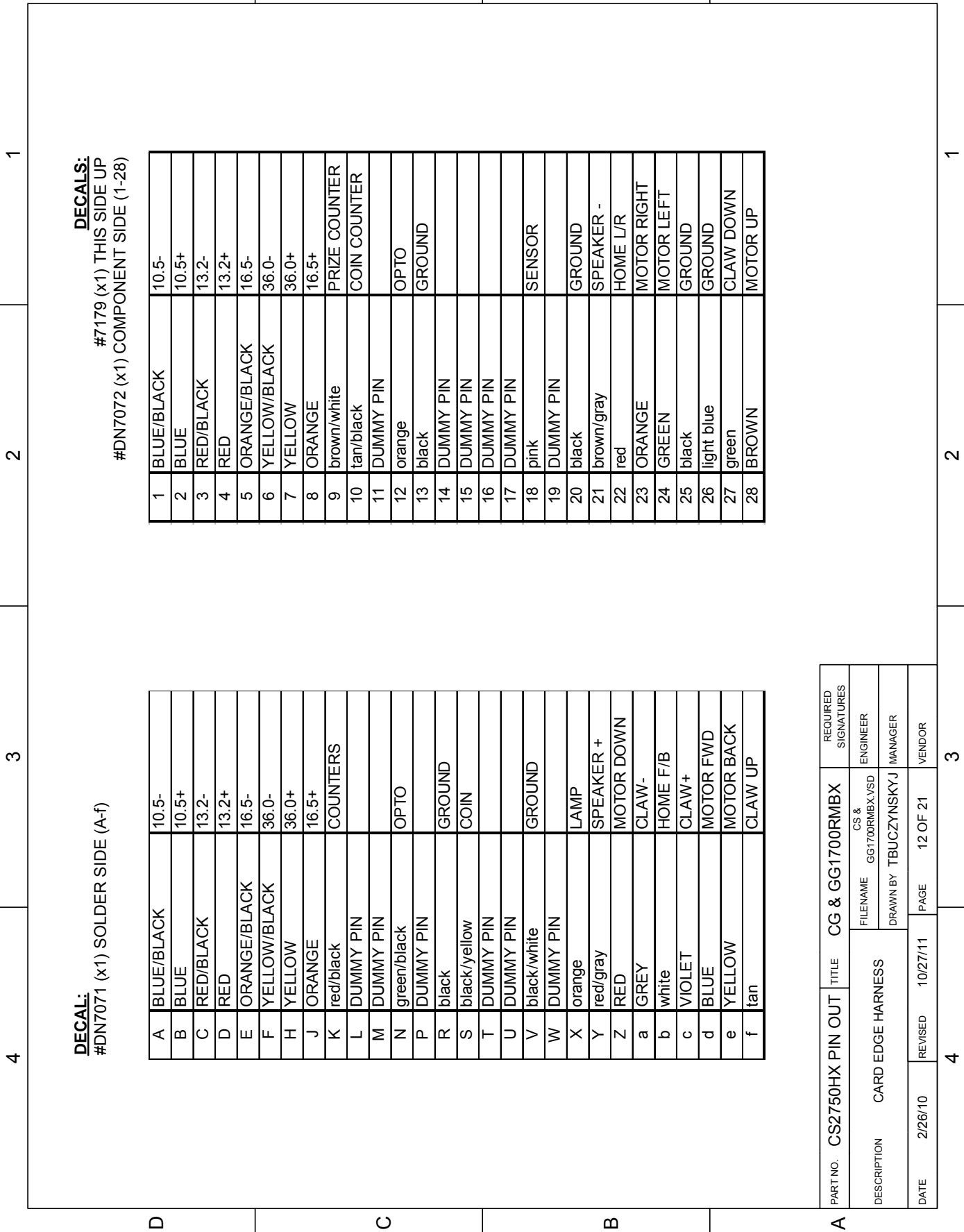

DECAL:
#DN7071 (x1) SOLDER SIDE (A-f)

A	BLUE/BLACK	10.5-
B	BLUE	10.5+
C	RED/BLACK	13.2-
D	RED	13.2+
E	ORANGE/BLACK	16.5-
F	YELLOW/BLACK	36.0-
H	YELLOW	36.0+
J	ORANGE	16.5+
K	red/black	COUNTERS
L	DUMMY PIN	
M	DUMMY PIN	
N	green/black	OPTO
P	DUMMY PIN	
R	black	GROUND
S	black/yellow	COIN
T	DUMMY PIN	
U	DUMMY PIN	
V	black/white	GROUND
W	DUMMY PIN	
X	orange	LAMP
Y	red/gray	SPEAKER +
Z	RED	MOTOR DOWN
a	GREY	CLAW-
b	white	HOME F/B
c	VIOLET	CLAW+
d	BLUE	MOTOR FWD
e	YELLOW	MOTOR BACK
f	tan	CLAW UP

DECALS:
#7179 (x1) THIS SIDE UP
#DN7072 (x1) COMPONENT SIDE (1-28)

1	BLUE/BLACK	10.5-
2	BLUE	10.5+
3	RED/BLACK	13.2-
4	RED	13.2+
5	ORANGE/BLACK	16.5-
6	YELLOW/BLACK	36.0-
7	YELLOW	36.0+
8	ORANGE	16.5+
9	brown/white	PRIZE COUNTER
10	tan/black	COIN COUNTER
11	DUMMY PIN	
12	orange	OPTO
13	black	GROUND
14	DUMMY PIN	
15	DUMMY PIN	
16	DUMMY PIN	
17	DUMMY PIN	
18	pink	SENSOR
19	DUMMY PIN	
20	black	GROUND
21	brown/gray	SPEAKER -
22	red	HOME L/R
23	ORANGE	MOTOR RIGHT
24	GREEN	MOTOR LEFT
25	black	GROUND
26	light blue	GROUND
27	green	CLAW DOWN
28	BROWN	MOTOR UP

PART NO.	CS2750HX PIN OUT	TITLE	CG & GG1700RMBX	REQUIRED SIGNATURES			
DESCRIPTION	CARD EDGE HARNESS	FILENAME	GG1700RMBX.VSD	ENGINEER			
		DRAWN BY	TBUCZYNSKYJ	MANAGER			
DATE	2/26/10	REVISED	10/27/11	PAGE	12 OF 21	VENDOR	

4 3 2 1 | 4 3 2 1 | 4 3 2 1 | 4 3 2 1

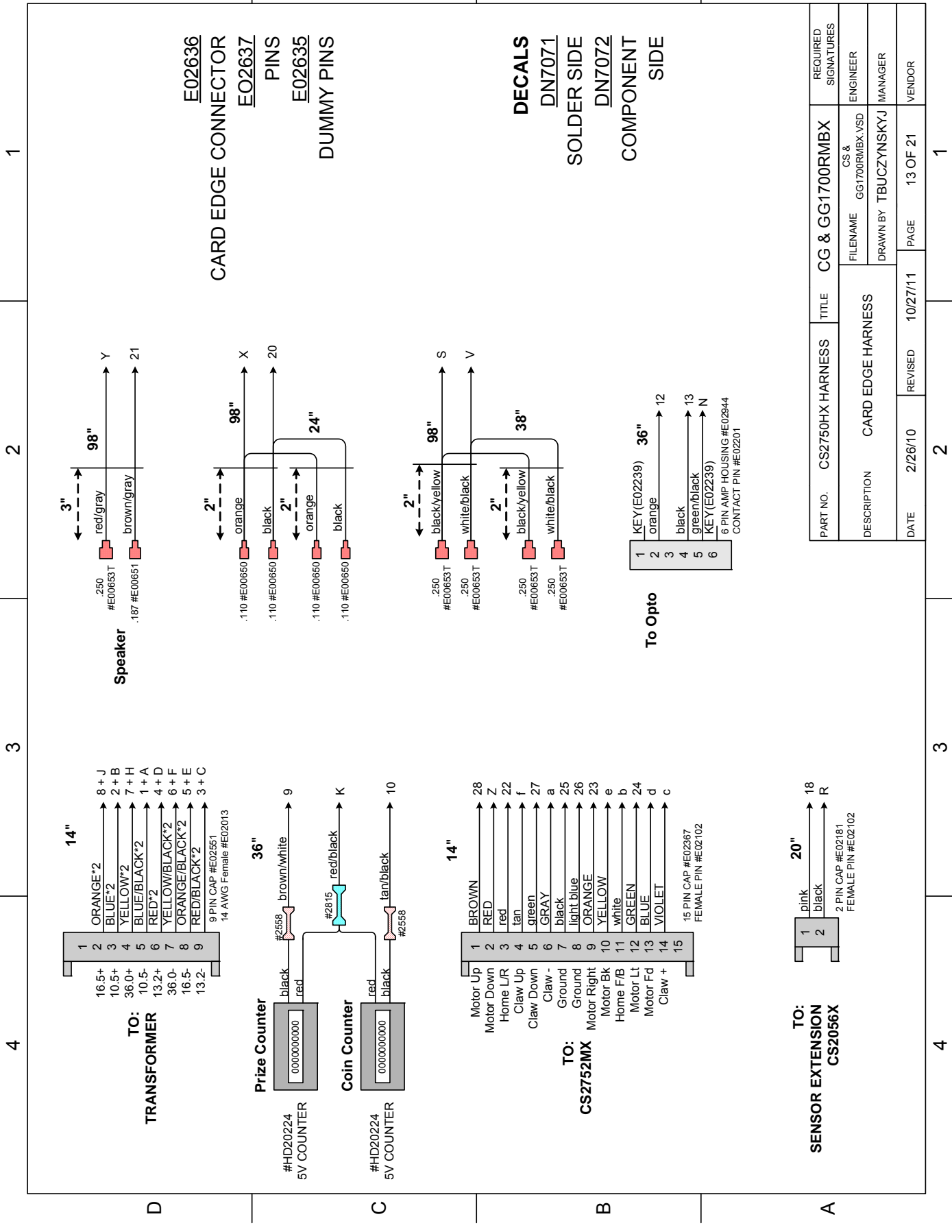

E02636
CARD EDGE CONNECTOR
E02637
PINS
E02635
DUMMY PINS

DECALS
DN7071
SOLDER SIDE
DN7072
COMPONENT SIDE

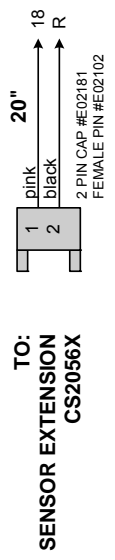
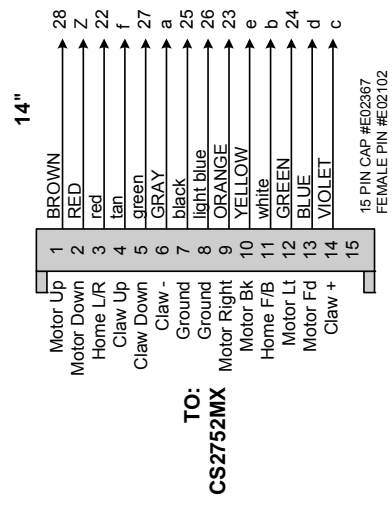
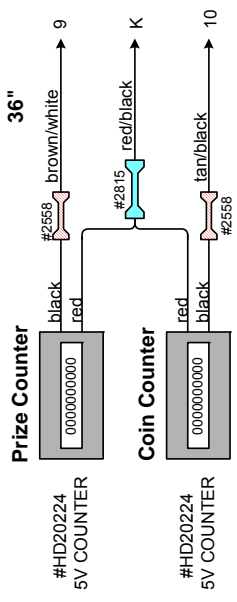
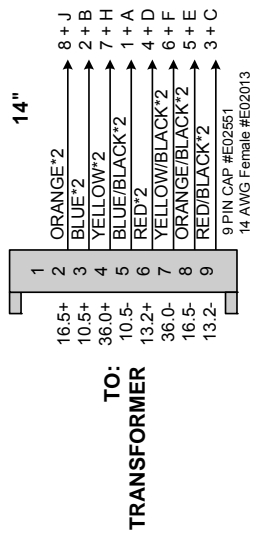
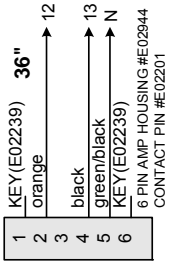
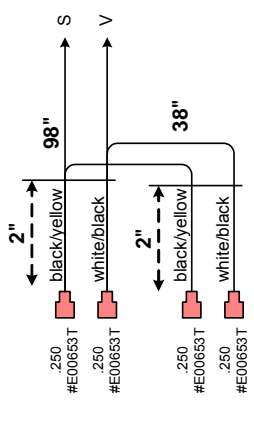
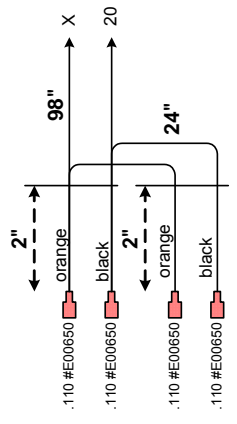
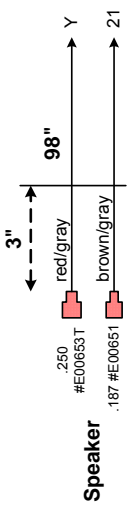

PART NO.	CS2750HX HARNESS	TITLE	CG & GG1700RMBX	REQUIRED SIGNATURES
DESCRIPTION	CARD EDGE HARNESS	FILENAME	CS & GG1700RMBX.VSD	ENGINEER
DATE	2/26/10	REVISED	10/27/11	MANAGER
			PAGE	VENDOR
			13 OF 21	

4 3 2 1

**To Wagon/Crane
Harness - CS2052AX**

CS ORANGE GENERIC #E07020
DECAL x 1

93 "

- 1 Crane Fwd Sw
- 2 Crane Back Sw
- 3 Claw Dwn Sw
- 4 Claw Up Sw
- 5 Gnd
- 6 Front/Back Motor +
- 7 Front/Back Motor -
- 8 Left/Right Motor +
- 9 Left/Right Motor -
- 10 Up/Down Motor +
- 11 Up/Down Motor -
- 12 Solenoid -
- 13 Solenoid +
- 14 Gnd
- 15

- 1 red
- 2 white
- 3 green
- 4 tan
- 5 black
- 6 YELLOW
- 7 BLUE
- 8 ORANGE
- 9 GREEN
- 10 BROWN
- 11 RED
- 12 * BROWN
- 13 * BLUE
- 14 light blue
- 15 15 PIN PLUG #E02144
SPLIT PIN #E02100
PIN 12 & 13 #E08260

- To Card
Edge - CS2750HX**
- 1 MotUp
 - 2 MotDn
 - 3 HomeL/R
 - 4 ClawUp
 - 5 ClawDn
 - 6 Claw-
 - 7 Gnd
 - 8 Gnd
 - 9 MotRight
 - 10 MotBack
 - 11 HomeF/B
 - 12 MotLeft
 - 13 MotFwd
 - 14 Claw +
 - 15 36V

- 1 BROWN
- 2 RED
- 3 red
- 4 tan
- 5 green
- 6 * BROWN
- 7 black
- 8 light blue
- 9 ORANGE
- 10 YELLOW
- 11 white
- 12 GREEN
- 13 BLUE
- 14 * BLUE
- 15 15 PIN PLUG #E02144
SPLIT PIN #E02100
PIN 6 & 14 # E08260

#E02997 - 2 CONDUCTOR CABLE

D C B A

PART NO.	CS2752MX	TITLE	CG & GG1700RMBX	REQUIRED SIGNATURES
DESCRIPTION	MAIN/WAGON LOWER HARNESS	FILENAME	CS & GG1700RMBX.VSD	ENGINEER
DATE	2/26/10	REVISED	10/27/11	MANAGER
		PAGE	14 OF 21	VENDOR

4 3 2 1

4 3 2 1

D C B A

CS ORANGE GENERIC #E07020
DECAL x 1

112"

P6

1	brown
2	red/black
3	orange/black
4	yellow
5	green
6	light blue
7	ORANGE
8	gray
9	white
10	black/white
11	tan
12	BLACK
13	
14	
15	

P1

1	brown
2	red/black
3	orange/black
4	yellow
5	green
6	light blue
7	ORANGE
8	gray
9	white
10	black/white
11	tan
12	BLACK

12 PIN PLUG #E02106
SPLIT PIN #E02100

15 PIN PLUG #E02144
SPLIT PIN #E02100

DISPLAY - P6

**TO DISPLAY
PCB - P1**

PART NO.	CS2754LX	TITLE	CG & GG1700RMBX	REQUIRED SIGNATURES
DESCRIPTION	DISPLAY HARNESS	FILENAME	CS & GG1700RMBX.VSD	ENGINEER
DATE	2/26/10	REVISED	10/27/11	MANAGER
			PAGE	15 OF 21
				VENDOR

4 3 2 1

4 3 2 1

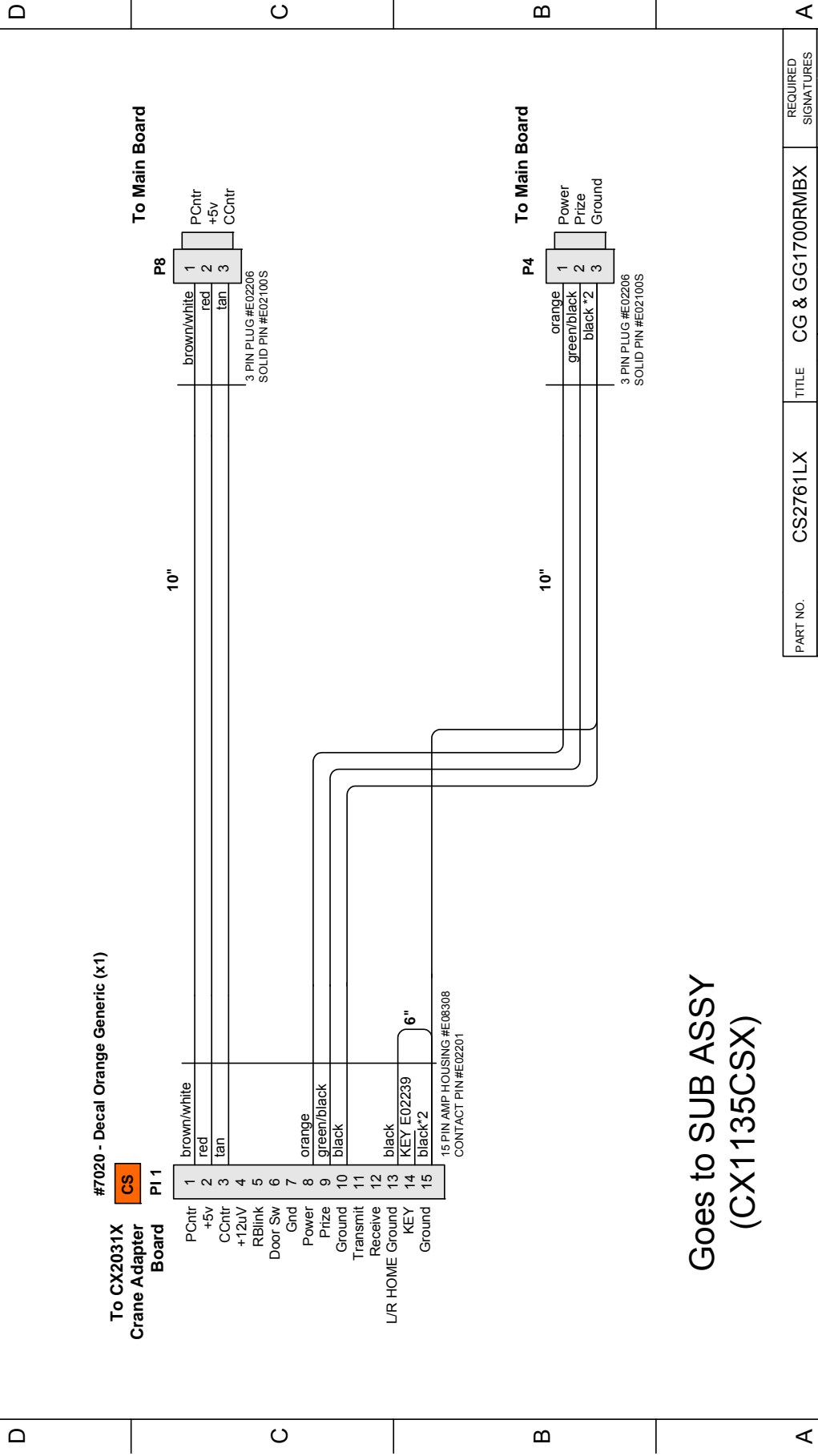

#7020 - Decal Orange Generic (x1)

To CX2031X
Crane Adapter
Board

CS
PI 1

To Main Board

P8

1	brown/white
2	red
3	tan

3 PIN PLUG #E02206
SOLID PIN #E02100S

L/R HOME Ground

KEY E02239

KEY

Ground

6"

15 PIN AMP HOUSING #E08308
CONTACT PIN #E02201

To Main Board

P4

1	orange
2	green/black
3	black*2

3 PIN PLUG #E02206
SOLID PIN #E02100S

Goes to SUB ASSY
(CX1135CSX)

PART NO.	CS2761LX	TITLE	CG & GG1700RMBX	REQUIRED SIGNATURES
DESCRIPTION	METER/OPTO INTERCONNECT HARNESS	CS & FILENAME	GG1700RMBX.VSD	ENGINEER
DATE	2/26/10	REV/USED	10/27/11	MANAGER
		PAGE	16 OF 21	VENDOR

4 3 2 1

4 3 2 1

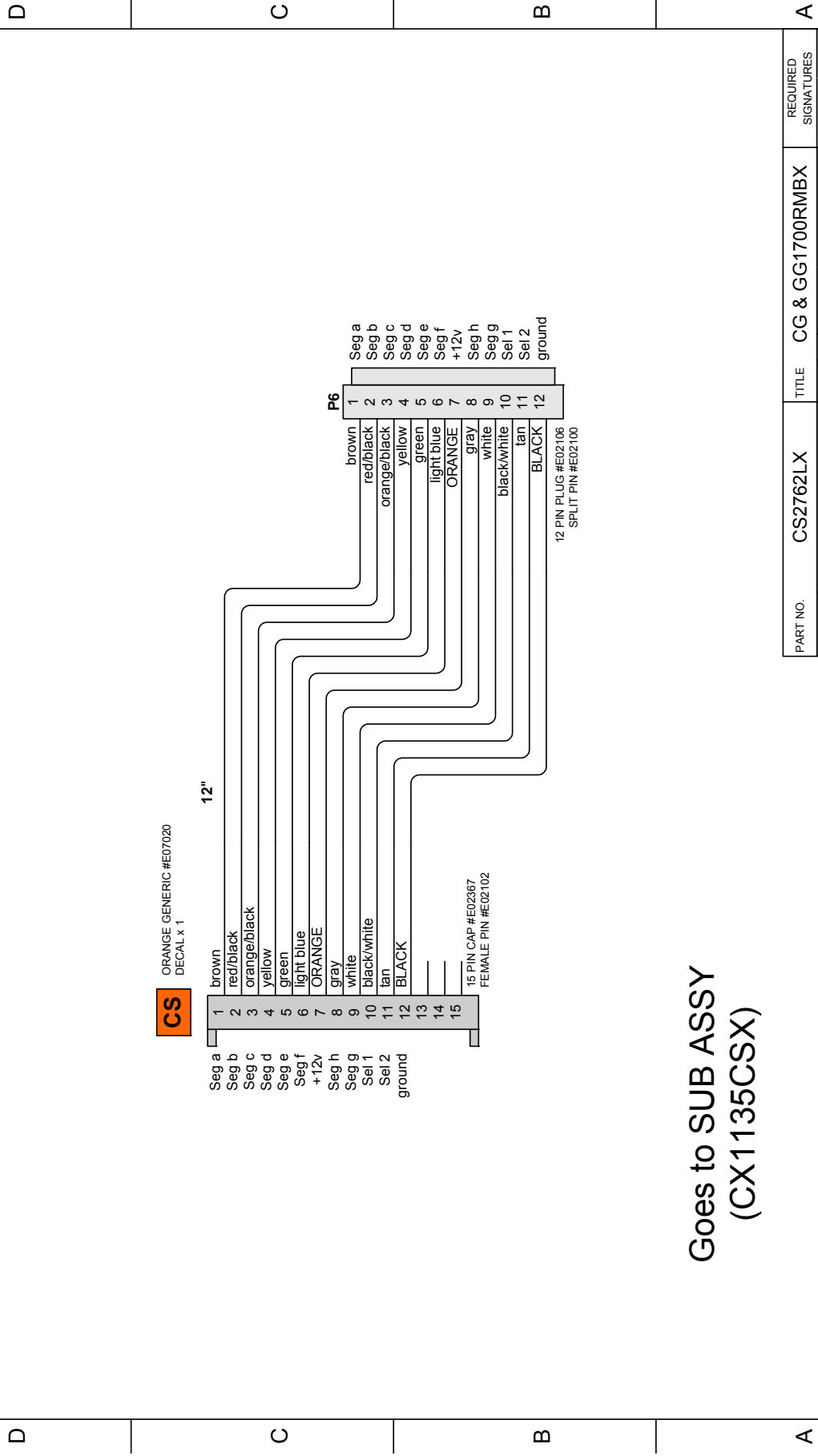

CS ORANGE GENERIC #E07020
DECAL x 1

- 1 brown
- 2 red/black
- 3 orange/black
- 4 yellow
- 5 green
- 6 light blue
- 7 ORANGE
- 8 gray
- 9 white
- 10 black/white
- 11 tan
- 12 BLACK
- 13
- 14
- 15

- 1 brown
- 2 red/black
- 3 orange/black
- 4 yellow
- 5 green
- 6 light blue
- 7 ORANGE
- 8 gray
- 9 white
- 10 black/white
- 11 tan
- 12 BLACK

12 PIN PLUG #E02106
SPLIT PIN #E02100

15 PIN CAP #E02367
FEMALE PIN #E02102

Goes to SUB ASSY
(CX1135CSX)

PART NO.	CS2762LX	TITLE	CG & GG1700RMBX	REQUIRED SIGNATURES
DESCRIPTION	DISPLAY ADAPTER HARNESS	FILENAME	CS & GG1700RMBX.VSD	ENGINEER
DATE	2/26/10	REVISED	10/27/11	MANAGER
			PAGE	VENDOR
			17 OF 21	

4 3 2 1

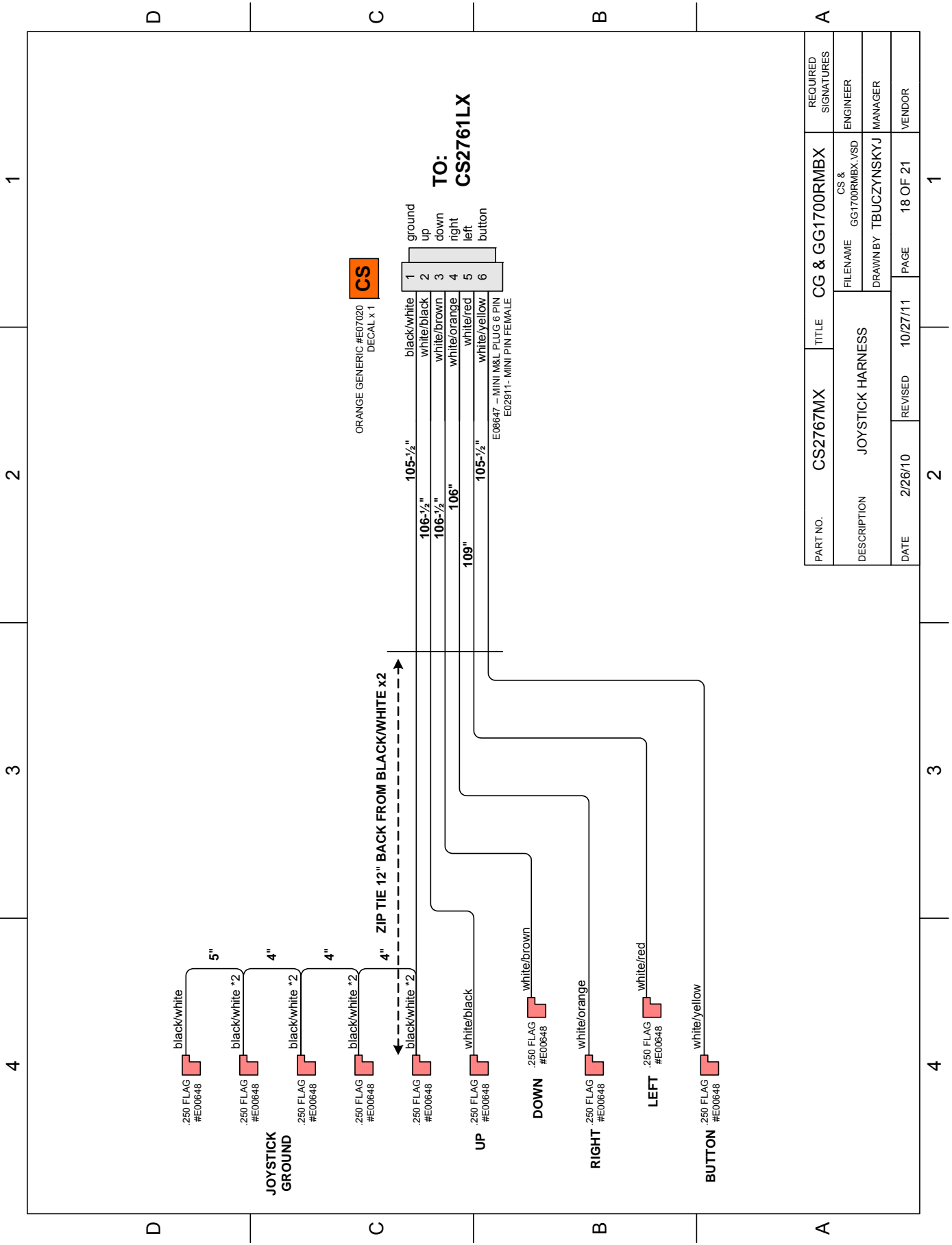

CS

ORANGE GENERIC #E07020
DECAL x 1

**TO:
CS2761LX**

1	ground
2	up
3	down
4	right
5	left
6	button

black/white
white/black
white/brown
white/orange
whitered
white/yellow
E08647 - MINI M&L PLUG 6 PIN
E02911 - MINI PIN FEMALE

PART NO.	CS2767MX	TITLE	CG & GG1700RMBX	REQUIRED SIGNATURES
DESCRIPTION	JOYSTICK HARNESS	FILENAME	CS & GG1700RMBX.VSD	ENGINEER
DATE	2/26/10	REVISED	10/27/11	MANAGER
		PAGE	18 OF 21	VENDOR

4 3 2 1

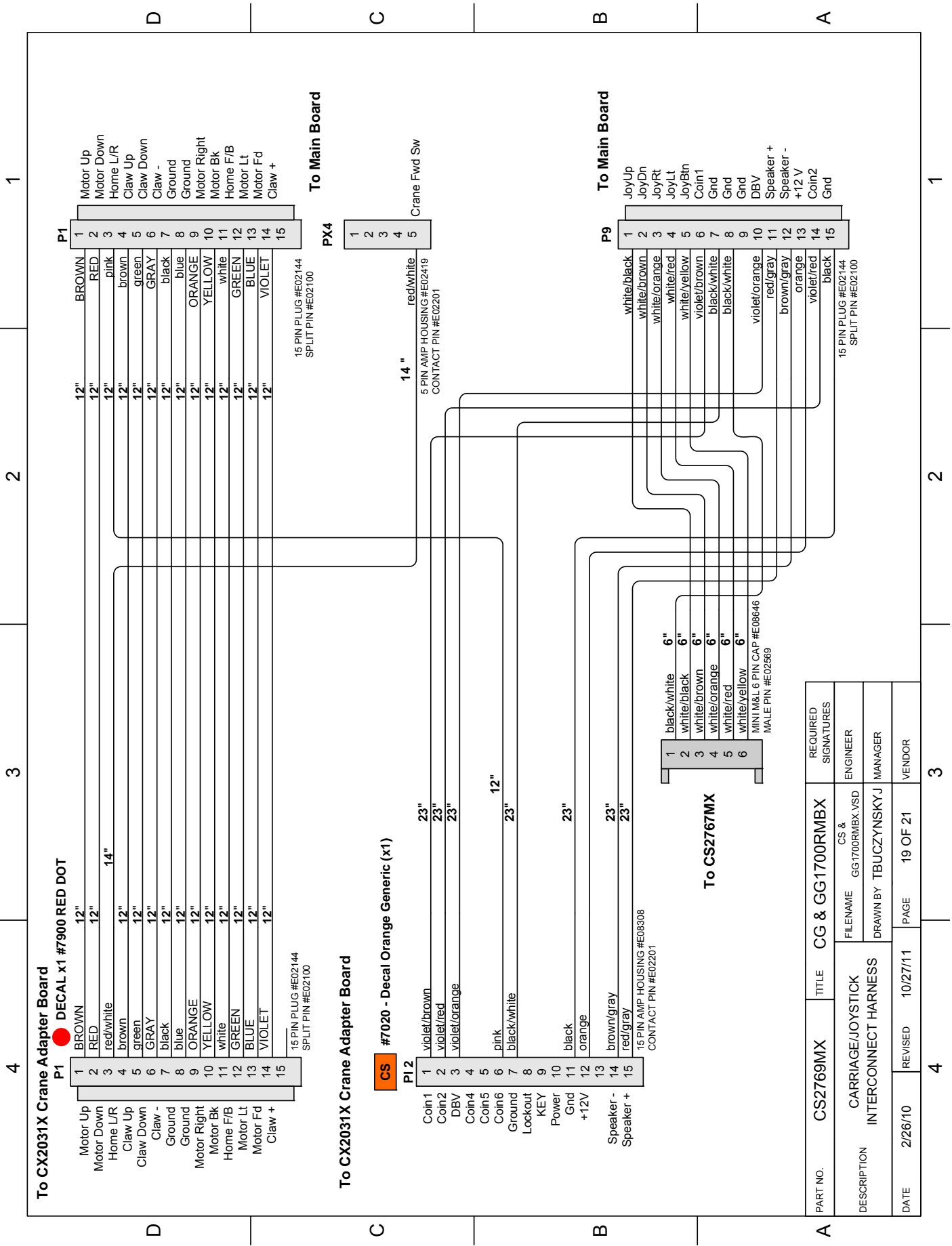

Part No.	CS2769MX	Title	CG & GG1700RMBX	Required Signatures
Description	CARRIAGE/JOYSTICK INTERCONNECT HARNESS	FILENAME	GG1700RMBX.VSD	ENGINEER
DATE	2/26/10	REVISED	10/27/11	MANAGER
		PAGE	19 OF 21	VENDOR

4 3 2 1

D C B A

CX

KEY	P10
16.5+	1
10.5+	2
36.0+	3
10.5-	4
13.2+	5
36.0-	6
16.5-	7
13.2-	8
	9

KEY #E02549
 1 ORANGE
 2 BLUE
 3 YELLOW
 4 BLUE/BLACK
 5 RED
 6 YELLOW/BLACK
 7 ORANGE/BLACK
 8 RED/BLACK
 9 PIN PLUG #E02282
 SPLIT PIN #E02100

KEY	P10
16.5+	1
10.5+	2
36.0+	3
10.5-	4
13.2+	5
36.0-	6
16.5-	7
13.2-	8
	9

ORANGE
 BLUE
 YELLOW
 BLUE/BLACK
 RED
 YELLOW/BLACK
 ORANGE/BLACK
 RED/BLACK
 9 PIN PLUG #E02282
 SPLIT PIN #E02100

10"

QTY 1 PER GAME

PART NO.	CX2068X	TITLE	CG & GG1700RMBX	REQUIRED SIGNATURES
DESCRIPTION	POWER INTERCONNECT	FILENAME	CG1700RMBX.VSD	ENGINEER
DATE	2/26/10	DRAWN BY	TBUCZYNSKYJ	MANAGER
	REVISED	10/27/11	PAGE	20 OF 21
				VENDOR

WHEN USED IN
CS1700RMBX
GG1700RMBX
 IT IS PART
 OF CX1135CSX

GOES TO SUB ASY

4 3 2 1

D C B A

1 2 3 4

D C B A

#2764 - 110V AC FAN

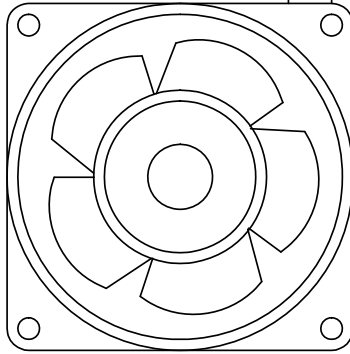

LEAVE @ FULL LENGTH

MS



TO:
CS2064X WHEN USED IN
CS/GG1700RMBX

3 PIN PLUG #2206
SOLID PIN #2100S
PIN 2 #E08260

12"

13"

#E20217 GREEN/YELLOW (600V)

black
GREEN/YELLOW
black

GOES TO FLOOR

PART NO.	MS2764X	TITLE	CG & GG1700RMBX	REQUIRED SIGNATURES
DESCRIPTION	SMALL AC FAN ASY	FILENAME	CS & GG1700RMBX.VSD	ENGINEER
DATE	2/26/10	DRAWN BY	TBU CZYNSKYJ	MANAGER
REVISED	10/27/11	PAGE	21 OF 21	VENDOR

2 3 4 1

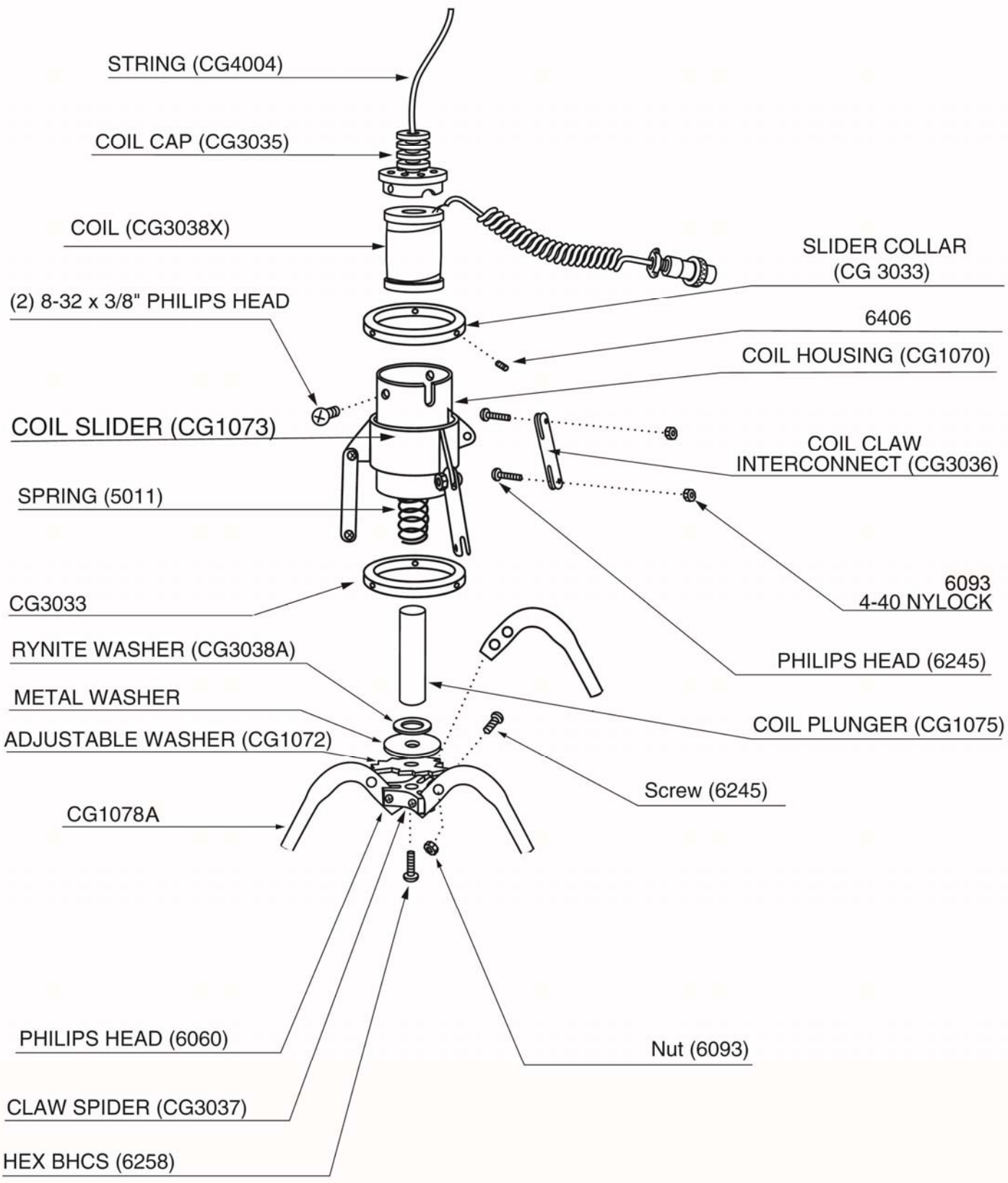

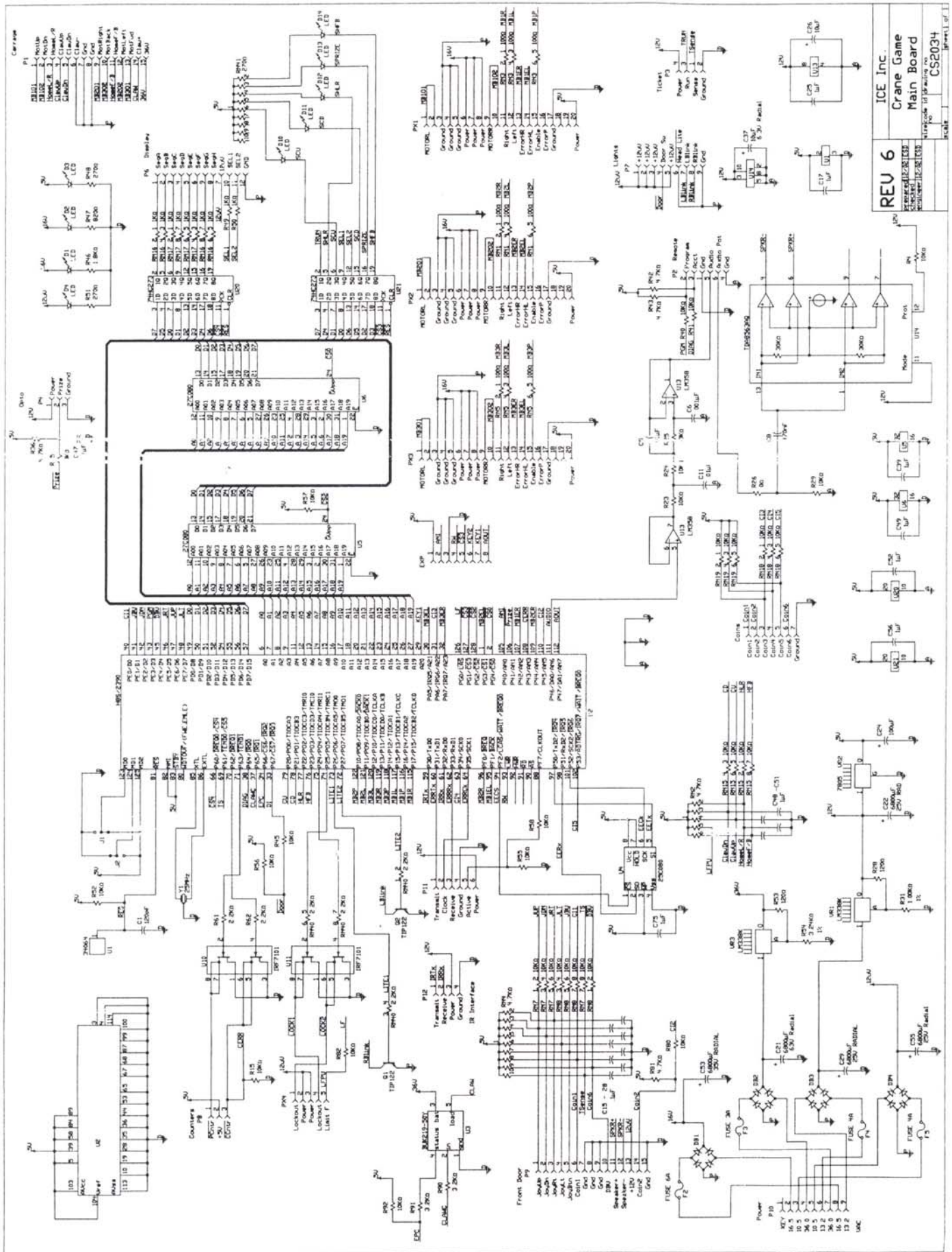

ICE Inc.
Crane Game
Main Board
REV 6
ICE INC. 11228 E. 28th St.
DENVER, CO 80231
CS2034

MECHANICAL PARTS

655	Square Drive Screw, Black 3/4"
655S	Square Drive Screw, Silver 5/8"
4006	Foam Weather-stripping
5006	Cash Box
5011	Solenoid Spring
6356	Hex Spacer, Aluminum 2-56 x 3/8"
6364	Plastic Glides
6365	Mirror Clip
BC1018NP	Podium
CG1078AX	Claw
CG2014	4 way Joystick w/Push Button
CG3036	Claw/Coil Interconnects
CG5014	"T" Lock, 90 deg. swing
CG5015	"T" lock - Lock Barrel
CH1052	Rare Earth Magnet
CS1006NP	Door Assembly
CS1034	Clip Holder
CS1035	Clip Spacer
CS1036	Adjusting Clip
CS1037	Switch Trigger
CS1050	Drive Pulley, Motor
CS1058	Wagon Drive Shaft
CS1066	Spring
CS3008A	IGUS Micro Track 42 Link Section
CS3008B	IGUS Mounting Link w/modified end
CS3008C	IGUS Mounting Link
CS3008D	IGUS Quick Connect Mounting Link
CS3013	Coin Slide
CS3025	Prize Sensor Mirror
CS3026	Rear Mirror
CS3027	Door Glass
CS3028	Side Glass
CS3030	Guide Pulley, Shaft
CS3031	O-ring Retainer
CS3032	String Spool

CS3040	Guide Pulley, Idler
CS3041	Drive Pulley, Idler
CS3042	String Guide
CS4001	O-Ring, Large Urethane
CS4003	O-Ring, Small Urethane
CS4004	String
FP1004	Foot Mounting Plate
FP2007	4" Speaker

ELECTRONIC / ELECTRICAL

8312	PLL Fluorescent Light Bulb, 40 watt
8422	Sub-miniature Micro Switch
E08452	Micro Switch, Standard Size - Basic
BC2032X	Display P.C. Board Assembly
BW2017	Bulb Retainer Clip
BW2018	Light Bulb Retainer
CS2008	Globe Motor DC 24 volt
CG2012	Hamlin Reed Switch
CS2002X	Transformer
CS1700RMBX	Removable Main Board assembly
CS2039X	Prize Sensor Opto P.C. Board
CS2050X	Door Harness
CS2052AX	Harness Assembly, Upper
CS2053X	Wagon / Crane Harness
CS2054X	Display Harness
CS8449X	Fluorescent Light Ballast, Work Horse 3
PP250X	Light Bulb Socket, PLL

Part#	Description	# Per Game	Trim Size
CS7300	Cabinet Side Left	1	29.5" x 23.5"
CS7301	Cabinet Side Right	1	29.5" x 23.5"
CS7302	Side Marquee	2	9.4375" x 22.625"
CS7303	Front Door Lower	1	11.0" x 20.375"
CS7304	Front Door Left Strip	1	2.5" x 17.4375"
CS7305	Front Door Right Strip	1	3.875" x 13.625"
CS7306	Prize Door	1	6.375" x 7.875"
CS7308	Mirror	1	24.375" x 16.875"
CS7312	Control Panel	1	5" x 14"
CS7327	Front Marquee	1	8.125" x 14.875"
CS7007	ICE logo	1	4.25" x 2.875"
CS7040	Remove 4 screws decal	1	3.5625" x 5.75"



WARRANTY POLICY

I.C.E. Inc warrants all components in new machines to be free of defects in materials and workmanship for the period listed below:

- 180 days on Main PCB's, Computers & Motors
- 1 year on all LCD monitor panels
- 90 days on all other electronic and mechanical components
- 30 days on all I.C.E. repairs and parts purchases

I.C.E. Inc shall not be obligated to furnish a warranty request under the following conditions:

- Equipment or parts have failed through normal wear and tear
- Equipment has been subjected to unwarranted stress, abuse or neglect
- Equipment has been damaged as a result of arbitrary repair/modification

Products will only be covered under warranty by obtaining an I.C.E. authorized RMA #. To obtain an RMA # please provide I.C.E. tech support with the game serial # or original I.C.E. invoice # and a detailed description of the failure or fault symptoms.

I.C.E. Inc will assume no liability whatsoever for costs associated with labor or travel time to replace defective parts. All defective warranty covered components will be replaced with new or factory refurbished components equal to OEM specifications.

I.C.E. Inc will cover domestic UPS ground, or comparable shipping costs during the warranty period. International or expedited shipments are available for an additional charge. To obtain credit defective parts must be returned to I.C.E. Inc, at the customer's expense, within 30 days. After 30 days a 15% re-stocking fee will apply to all returns.

ICE distributors are independent, privately owned and operated. In their judgment, they may sell parts and/or accessories other than those manufactured by I.C.E. Inc. We cannot be responsible for the quality, suitability or safety of any non-I.C.E. part or modification (including labor) that is performed by such a distributor.

Innovative Concepts in Entertainment
10123 Main St.
Clarence, NY 14031
Phone #: (716) - 759 – 0360
Fax #: (716) – 759 – 0884
www.icegame.com